

RCA

video cassette recorder user's guide

VR643HF

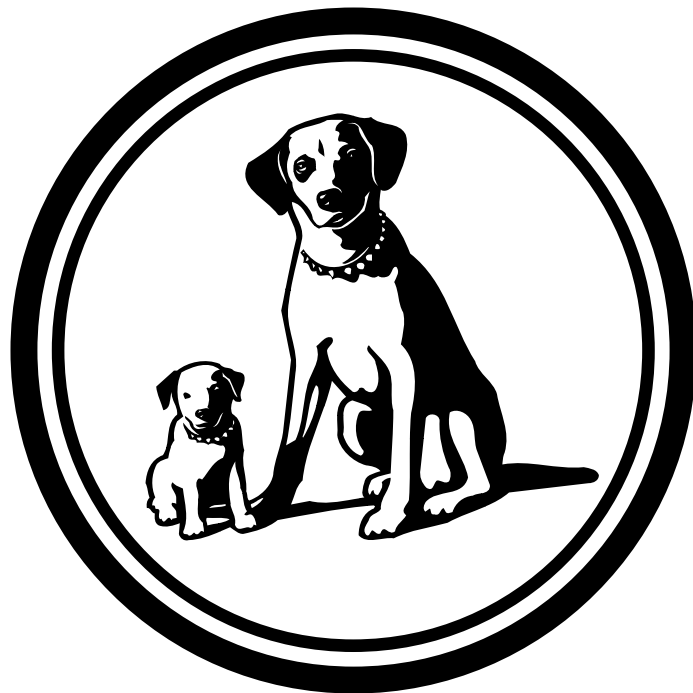

IMPORTANT INFORMATION

WARNING

RISK OF ELECTRIC SHOCK DO NOT OPEN

To reduce the risk of electric shock, do not remove cover (or back). No user serviceable parts inside. Refer servicing to qualified service personnel.



This symbol indicates "dangerous voltage" inside the product that presents a risk of electric shock or personal injury.



This symbol indicates important instructions accompanying the product.

WARNING

To reduce the risk of fire or shock hazard, do not expose this product to rain or moisture.

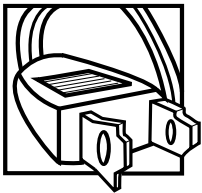

Caution: To reduce the risk of electric shock, match wide blade of plug to wide slot, fully insert.

Attention: Pour éviter les chocs électriques, introduire la lame la plus large de la fiche dans la borne correspondante de la prise et pousser jusqu'au fond.

Refer to the identification/rating label located on the back panel of your product for its proper operating voltage.

FCC Regulations state that unauthorized changes or modifications to this equipment may void the user's authority to operate it.

Cable TV Installer: This reminder is provided to call your attention to Article 820-40 of the National Electrical Code (Section 54 of the Canadian Electrical Code, Part 1) which provides guidelines for proper grounding and, in particular, specifies that the cable ground shall be connected to the grounding system of the building as close to the point of cable entry as practical.

Product Registration

Please fill out the product registration card and return it immediately. Returning this card allows us to contact you if needed.

Keep your sales receipt to obtain warranty parts and service and for proof of purchase. Attach it here and record the serial and model numbers in case you need them. The numbers are located on the back of the product.

Model No. **VR643HF** _____

Serial No. _____

Purchase Date: _____

Dealer/Address/Phone: _____

TABLE OF CONTENTS

First Things First	3
Setting up the VCR	7
Using the Menu to Set Up Features	8
Language	8
Cable Box Setup	8
VCR Channels List	10
To Auto Channel Search	10
To Change the Signal Type	11
To Add or Remove Channels	11
Time and Date	12
Auto Clock Set Feature	12
Set the Time and Date Manually	14
VCR Plus+ Channels	15
Additional Set-Up Features in the PREFERENCES Menu	17
Remote VCR1/VCR2 Option	17
Auto Play	18
Auto TV/VCR	18
Front Panel (VCR Display)	19
VCR Basics	21
Remote Buttons	22
Component Buttons	22
VCR Function Buttons	22
TV Function Buttons	23
Playing a Tape	24
Automatic Rewind	24
Tape Eject	25
Recording	25
Check the Safety Tab	25
Recording	27
Recording Features	28
Express Recording	28
Timer Recording	29
Timer Recording with VCR Plus+	30
Stopping a Timer Recording	32
Reviewing and Clearing Programs	32
Recording Broadcast Stereo TV or SAP (Second Audio Program)	32
Recording Audio Only	33
Using Two VCRs for Copying and Editing Tapes	34

TABLE OF CONTENTS

Programming the Remote	35
To Control a TV	36
Other Features	37
COMMERCIAL▶▶ADVANCE	38
MOVIE▶▶ADVANCE	41
Picture Search Options	43
Forward and Reverse Search	43
Slow Motion	44
Frame Advance	44
Index Search	44
Go-To Search	45
Time Counter	45
Tracking	46
On-Screen Displays	46
Audio Set-Up Features	47
Reception	48
Tape Playback	48
Connections	49
Things to Know Before Connecting Components	49
Connecting Your VCR	50
TV with RF Jack Only	52
TV with Audio/Video Jacks	53
TV with Audio/Video Jacks and Cable Box to Unscramble Pay Channels Only	54
TV with RF Jack and Satellite Receiver	55
TV with Audio/Video Jacks and Satellite Receiver	56
Appendix A: Reference	57
Front Panel	58
Display Panel	59
Back Panel	60
Troubleshooting Tips	61
Questions and Answers About COMMERCIAL▶▶ADVANCE	64
Specifications	65
Cleaning the VCR	65
Limited Warranty	66
Index	67

FIRST THINGS FIRST

HI, MY NAME IS ROGER...

and I wrote this User's Guide. It's my job to see that you have a rewarding user manual experience. And, I think you'll be pleased with the features that can be accessed through the on-screen menus.

READ THE FIRST THREE SECTIONS

The first three sections of the manual introduce you to your VCR, and show you how to set the VCR up and use the on-screen menus. Reading these sections gives you the basic information you need to use your VCR.

WHAT'S LEFT?

The rest of the book highlights playback and recording information, contains a detailed connections section, and a reference section that includes troubleshooting tips, limited warranty, and index.

1 FIRST THINGS FIRST



2 SETTING UP THE VCR



3 VCR BASICS



4 RECORDING



5 PROGRAMMING THE REMOTE



6 OTHER FEATURES



7 CONNECTIONS

READ ME!

These note boxes give you tips for your new video cassette recorder.

FIRST THINGS FIRST

STEP 1: UNPACK THE BOX

The following items come packed in the box:

- VCR
- Remote control
- RF coaxial cable

STEP 2: INSTALL BATTERIES IN THE REMOTE CONTROL

Follow these steps whenever you need to install or change the batteries in your VCR remote.

1. Remove the cover of the battery compartment.
2. Place batteries in the remote, matching the + and – ends of each battery to the diagram inside the compartment.
3. Replace the cover.

STEP 3: CONNECT YOUR VCR

If you connect your VCR to your home antenna or cable system and then to your TV, use the VCR's IN FROM ANT and OUT TO TV jacks for a good signal as shown.

If you have a TV with AUDIO/VIDEO jacks, use the jacks for a better connection. Refer to the *Connections* section, toward the back of the manual.

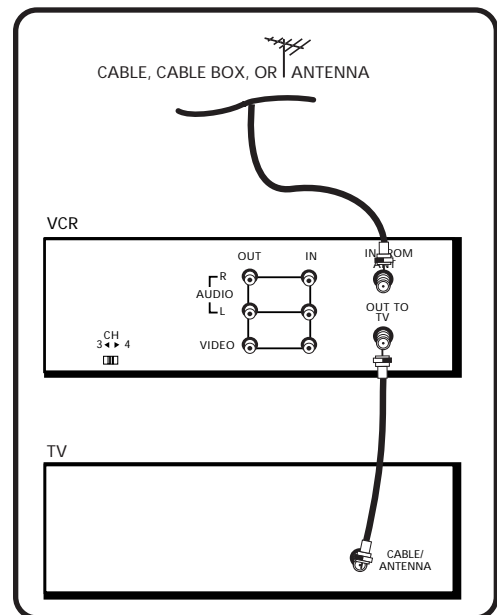

FIRST THINGS FIRST

STEP 4: PLUG IN THE VCR

Match the wide blade of the plug with the wide slot in the outlet. Be sure to insert the plug completely.

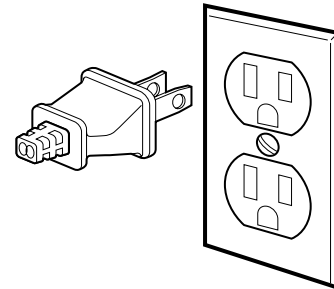

STEP 5: TUNE THE TV

Tune the TV to the VCR viewing channel. The VCR viewing channel is channel 3 or 4 or the TV's video input, depending on the connection you've chosen.

- If you connect your VCR using the ANTENNA connectors with RF coaxial cable, set the 3CH4 switch to channel 3 or channel 4—the channel you want to use on your TV.
- If you connect your VCR using the AUDIO/VIDEO jacks with audio/video cables, select the TV's video input to see the signal. See the *TV Owner's Manual*.

STEP 6: TURN ON THE VCR

Press POWER on the VCR's front panel, or VCR on the remote to turn on the VCR. The VCR will begin Auto Channel Search. Once your local channels are stored in memory, the VCR searches for a channel carrying XDS (Extended Data Services) information to automatically set the time.

To complete setting up the VCR, you will need to understand how to move through and change items in the on-screen menus.

STEP 7: ACCESS THE MENUS

The MENU and number buttons let you access, select and change menu items. For example, to change the AUTO PLAY setting, you would do the following:

Auto Channel Search/Auto Clock

You can quit Auto Channel Search by pressing any key on the remote. However, doing so may prevent the time from being set automatically. Auto Clock will set the time, but you may have to set the time zone and daylight saving time manually before the time is correct.

Refer to the next section, *Setting up the VCR*, for more information on these features.

VCR Viewing Channel

When using only the IN FROM ANT and OUT TO TV jacks to connect your VCR, tune your TV to channel 3 or 4.

When using the audio/video jacks to connect your VCR, tune your TV to the TV's video input.

FIRST THINGS FIRST

1. Press MENU to display the VCR MAIN MENU.

```
VCR MAIN MENU
1 VCR Plus+
2 Timer Recordings
3 Time
4 Channels
5 Preferences
6 Audio
7 Language
0 Exit
```

2. Press 5 to display the PREFERENCES menu.

```
PREFERENCES
1 Remote Control: VCR1
2 Auto Play: ON
3 Auto TV/VCR: ON
4 Front Panel AUTO
5 Commercial Advance
0 Exit
```

3. Press 2 to switch Auto Play to ON or OFF.

```
PREFERENCES
1 Remote Control: VCR1
2 Auto Play: OFF
3 Auto TV/VCR: ON
4 Front Panel AUTO
0 Exit
```

See *Additional Set-Up Features* for detailed information about the Auto Play feature.

STEP 8: SET UP THE VCR

Once you understand how to move around through the menus, go to the next section to set up your VCR.

SETTING UP THE VCR

SET-UP FEATURES

Below is a list of features that you may want to set up before you begin using your VCR for the first time.

- Select a Language
- Set Up for a Cable Box
- Set up VCR Channel List (Auto Channel Search)
- Set Time Zone and Daylight-Saving Time (Auto Clock)
- Set the Time and Date Manually
- Set up VCR Plus+ Channels
- Set the Remote VCR1/VCR2 feature
- Set the Auto Play feature
- Set the Auto TV/VCR feature
- Set the Front Panel Brightness feature

1 FIRST THINGS FIRST



2 SETTING UP THE VCR



3 VCR BASICS



4 RECORDING



5 PROGRAMMING THE REMOTE



6 OTHER FEATURES



7 CONNECTIONS

SETTING UP THE VCR

USING THE MENU TO SET UP FEATURES

You can set up features by using the menu system. The features you may want to set up before you begin using your VCR are explained in this section.

LANGUAGE

Select your preferred language, and the on-screen displays will appear in that language.

1. Press MENU to display the VCR MAIN MENU.

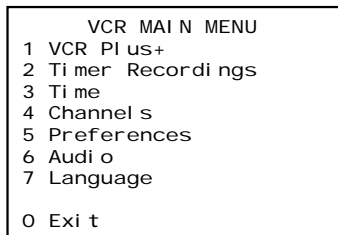

2. Press 7 to select the LANGUAGE menu.

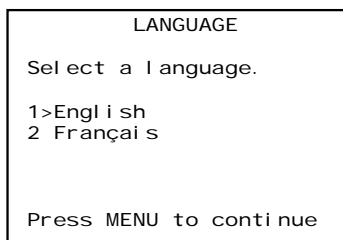

3. Select English or Français (French).

CABLE BOX SETUP

This setup applies only when all channels are received through the cable box. The VCR will automatically enter the output channel of the cable box when programming your VCR for timer recordings.

On-Screen Menus

Not all the VCR screens are shown in this manual when explaining the features.

SETTING UP THE VCR

1. Press MENU to display the VCR MAIN MENU.

```
VCR MAIN MENU
1 VCR Plus+
2 Timer Recordings
3 Time
4 Channels
5 Preferences
6 Audio
7 Language
0 Exit
```

2. Press 4 to display the CHANNELS menu.

```
CHANNELS
1 Auto Channel Search
2 Add/Remove Channels
3 Signal Type: CABLE
4 VCR Plus+ Channel List
5 Cable Box Setup
0 Exit
```

3. Press 5 to display CABLE BOX SETUP. Then select one of the three choices.

```
CABLE BOX SETUP
Do you use your cable
box to receive ALL
channels or only SOME
Channels?
1 ALL channels
2 Only SOME channels
3 Cancel setup
```

4. If you selected ALL channels, enter the output channel of your cable box, usually 03, 04, or video line input and press MENU.

```
CABLE BOX SETUP
On what channel does
the VCR receive signals
from the cable box?
(usually 3, 4, or Video)
--
Enter 01-13 or INPUT
Press MENU to cancel
```

```
CABLE BOX SETUP
The VCR will now
receive all signals
from the cable box
on channel 04.
Press MENU to continue
```

Once you complete the setup, the VCR confirms that Cable Box Setup is complete

Cable Box Setup

ALL channels: enter two numbers for output channel of your cable box or press INPUT.

Only SOME channels: if you only use the cable box to tune premium channels.

Cancel setup: select to cancel.

SETTING UP THE VCR

VCR CHANNELS LIST

If you use a cable box for *all channels*, this step is not necessary. Your VCR may come with a channel list preset at the factory. Even though your VCR may come with a list, it's possible that you may want to add or eliminate some channels depending on whether they are active.

To Auto Channel Search

1. Press MENU to display the VCR MAIN MENU.

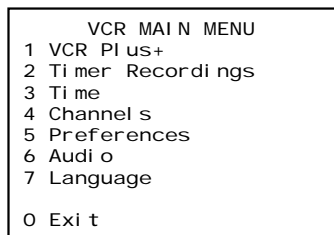

2. Press 4 to display the CHANNELS menu.

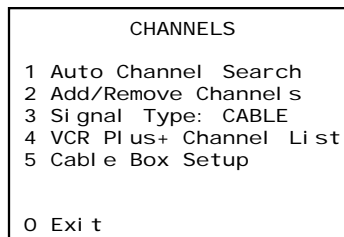

3. Press 1 to display the AUTO CHANNEL SEARCH menu.

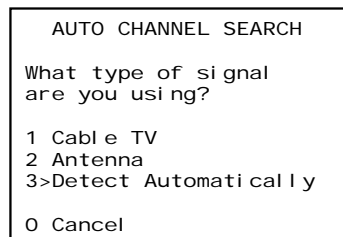

4. Select one of the three AUTO CHANNEL SEARCH options.

Choices one and two are self-explanatory. If you choose Detect Automatically, the VCR automatically detects which signal system you have attached to your VCR.

Auto Channel Search

Use the Auto Channel Search feature to place all available channels in memory.

If you ever change cable or antenna signals, you may need to Auto Channel Search again.

SETTING UP THE VCR

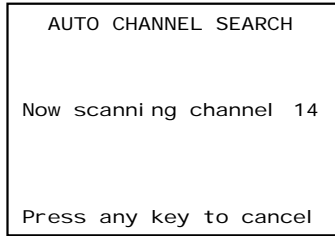

The VCR begins scanning for the available channels—this takes about one to two minutes. The lowest channel is tuned once the search is complete. Now pressing CHANNEL up or down should only select the active channels.

To Change the Signal Type

1. Press MENU to display the VCR MAIN MENU.
2. Press 4 to display the CHANNELS menu.
3. Press 3 to change the Signal Type between CABLE and ANTENNA.

To Add or Remove Channels

You may want to add or remove channels after you Auto Channel Search, especially if some of the channels have weak signals or you don't want to watch them.

1. Press MENU to display the VCR MAIN MENU.
2. Press 4 to display the CHANNELS menu.
3. Press 2 to display the ADD/REMOVE CHANNELS screen. Use CHANNEL up or down or number buttons to go to the channels you want to remove or add.

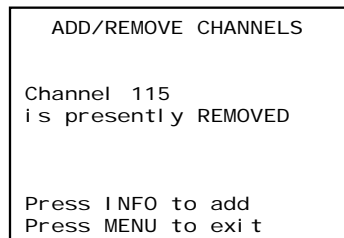
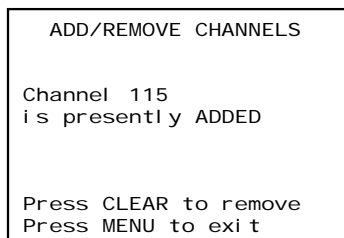

Detect Automatically

A strong cable or antenna signal in your area may cause Auto Detect to mis-detect. If this should happen, select 1 or 2 for the system you have.

Selecting Channels

The CHANNEL up and down buttons access those channels active in your VCR channel list.

You can still access channels not in the channel list by using the number buttons on the remote.

SETTING UP THE VCR

TIME AND DATE

The VCR gives you two ways to set the time and date. The Auto Clock feature which enables the VCR to update the clock each time you turn off the VCR. The Auto Clock feature is advantageous because it updates the time for you automatically. The second way is entering the time and date manually into the menu system.

AUTO CLOCK SET FEATURE

The Auto Clock feature is set to ON at the factory. In the ON setting, the VCR looks for a channel carrying XDS (Extended Data Services) information and updates the clock using the Coordinated Universal Time. After the clock is initially set, you may have to set the Time Zone and Daylight Saving features.

Set the Time Zone

1. Press MENU to display the VCR MAIN MENU.

```
VCR MAIN MENU
1 VCR Plus+
2 Timer Recordings
3 Time
4 Channels
5 Preferences
6 Audio
7 Language
0 Exit
```

2. Press 3 to display TIME menu.

```
TIME
1 Set Time and Date
2 Auto Clock Set: ON
3 Set Time Zone
4 Set Daylight Savings
0 Exit
```

Auto Clock Info

With a cable box, the VCR will not reset the clock after a power outage unless the cable box is set to the channel carrying the broadcast signal.

If Auto Clock Set is unsuccessful, try tuning the VCR (or cable box) to a channel carrying the XDS information (usually PBS), then turn the VCR off. If the time does not set within 10 minutes, set the time and date manually through the menu items.

Check local cable system or TV stations for availability of channels with XDS.

SETTING UP THE VCR

3. Press 3 to display the SET TIME ZONE screen.

```
SET TIME ZONE
What is your Time Zone?
1 Eastern
2 Central
3 Mountain
4 Pacific
5 Alaska
6 Hawaii
7>Automatic
Press MENU to continue
```

4. Select your time zone.

If you select Automatic for your time zone, the VCR sets the clock using the first Coordinated Universal Time information it finds. If the time is not correct, select another time zone or set the time and date through the menu system.

Set Daylight Saving Time

1. Press MENU to display the VCR MAIN MENU.
2. Press 3 to display the TIME menu.
3. Press 4 to display the SET DAYLIGHT SAVINGS menu.

```
SET DAYLIGHT SAVINGS
Does your area observe
Daylight Savings Time
from April to October?
1 Yes, DST is observed
2 No
3>Automatic
Press MENU to continue
```

4. Select one of the options.
- DST is the acronym for Daylight-Savings Time.
 - If you choose AUTOMATIC, the VCR sets the clock using the DST information broadcast in the signal (channel).

Spring forward; Fall backward

In the Spring, daylight-saving time begins on the first Sunday in April. Because the clock automatically changes from 2:00 AM to 3:00 AM (forward one hour), remember to include the extra hour for timer recording falling within this time frame.

In the Autumn, daylight-saving time ends on the last Sunday in October. The VCR clock automatically changes from 2:00 AM to 1:00 AM (back one hour). Therefore, it can affect your recording length.

Time/Date Display

Pressing INFO on the remote displays the time and date on the screen.

SETTING UP THE VCR

SET THE TIME AND DATE MANUALLY

If the AUTO CLOCK SET was unsuccessful, set the clock through the menu option. The AUTO CLOCK SET feature is set to OFF automatically when you set the clock this way.

1. Press MENU to display the VCR MAIN MENU.

```
VCR MAIN MENU
1 VCR Plus+
2 Timer Recordings
3 Time
4 Channels
5 Preferences
6 Audio
7 Language

0 Exit
```

2. Press 3 to display the TIME menu.

```
TIME
1 Set Time and Date
2 Auto Clock Set: ON
3 Set Time Zone
4 Set Daylight Savings

XDS Time Data was
not found.

0 Exit
```

3. Press 1 to display the SET TIME AND DATE menu.

```
SET TIME AND DATE

Time --:--
(hh:mm)

Date --/--/--

Press MENU to cancel
```

4. Enter the data using the number buttons. Press 0 before single-digit numbers and follow the on-screen directions.

```
SET TIME AND DATE

Time 12:34 PM

Date 11/18/97 Tuesday

Press CLEAR to correct
Press MENU to set
```

SETTING UP THE VCR

VCR PLUS+ CHANNELS

Using VCR Plus+ can make programming timer recordings for cable or off-air antenna easier, but you have to put in a little time right now to set up a channel list. A worksheet and abbreviated codes for typical cable services in the U.S. and Canada are provided.

1. Press MENU to display the VCR MAIN MENU.

```

VCR MAIN MENU
1 VCR Plus+
2 Timer Recordings
3 Time
4 Channels
5 Preferences
6 Audio
7 Language

0 Exit
    
```

2. Press 4 to display the CHANNELS menu.

```

CHANNELS
1 Auto Channel Search
2 Add/Remove Channels
3 Signal Type: CABLE
4 VCR Plus+ Channel List
5 Cable Box Setup

0 Exit
    
```

3. Press 4 to display the VCR Plus+ Channel List screen.

```

VCR+ Channel My Channel
5          --
4          --
3 -> -> -> --
2          --
1          --

Use CH+/- to select
Press 0-9 to change
Press MENU to save
    
```

4. Enter the data following the on-screen directions using your worksheet.

```

VCR+ Channel My Channel
5          46
4          --
3 -> -> -> 23
2          --
1          --

Use CH+/- to select
Press 0-9 to change
Press MENU to save
    
```

Two-Digit VCR Plus+ Channel Numbers for Cable TV (USA List)

35	American Movie Classics
39	Arts &-Entertainment
57	Black Entertainment
54	Bravo
42	Cable News Network
45	Cinemax
98	Cinemax 2
37	The Discovery Channel
53	The Disney Channel
63	Entertainment Television
34	ESPN Sports Network
47	The Family Channel
33	Home Box Office
95	Home Box Office 2
96	Home Box Office 3
51	The Learning Channel
46	Lifetime
58	The Movie Channel
48	Music Television
49	The Nashville Network
38	Nickelodeon
64	Nostalgia Television
99	Quality Value Cable
41	Showtime
97	Showtime 2
59	Sports Channel
52	Turner Network Television
44	USA-Network
62	Video Hits 1
93	Viewer's Choice 1
94	Viewer's Choice 2
55	WGN Chicago
43	WTBS Atlanta
60	WWOR-New York

See next page for Canadian List

VCR Plus+ Channel List

Refer to your local television list for a complete VCR Plus+ channel list for your viewing area or contact your cable company. Using the list may save you some time.

SETTING UP THE VCR

ADDITIONAL SET-UP FEATURES IN THE PREFERENCES MENU

The features in this section are all accessed through the PREFERENCES menu.

1. Press MENU to display the VCR MAIN MENU.

```
VCR MAIN MENU
1 VCR Plus+
2 Timer Recordings
3 Time
4 Channels
5 Preferences
6 Audio
7 Language
0 Exit
```

2. Press 5 to display the PREFERENCES menu.

```
PREFERENCES
1 Remote Control: VCR1
2 Auto Play: ON
3 Auto TV/VCR: ON
4 Front Panel AUTO
5 Commercial Advance
0 Exit
```

Now you are ready to select an item from the menu to set up.

REMOTE VCR1/VCR2 OPTION

If you own a compatible RCA, GE, or ProScan remote that has a VCR2, VCR2•LD, or VCR2•DVD button, this feature allows you to set this VCR to respond to that button.

Press 1 to select the Remote Control item. Then press the VCR2, VCR2•LD, or VCR2•DVD button to change.

```
PREFERENCES
(PRESS VCR2 TO CHANGE)
2 Auto Play: ON
3 Auto TV/VCR: ON
4 Front Panel AUTO
5 Commercial Advance
0 Exit
```

```
PREFERENCES
1 Remote Control: VCR2
2 Auto Play: OFF
3 Auto TV/VCR: OFF
4 Front Panel AUTO
5 Commercial Advance
0 Exit
```

Remote Control Option

Changing the remote option to VCR2 disables the remote that came with your VCR.

SETTING UP THE VCR

The VCR will only respond to the compatible remote's VCR2, VCR2•LD, or VCR2•DVD button. If you change the remote setting to VCR2, the remote that came with your VCR will no longer control it.

Use the compatible remote to change the remote setting back to VCR1. Display the PREFERENCES menu, press 1, and then press VCR on the VCR's remote.

AUTO PLAY

This feature allows the VCR to automatically start playing when you insert a tape with the safety tab removed. Press 2 to switch between ON or OFF.

- Select ON if you want a tape with its safety tab removed—a prerecorded movie, for example—to start playing automatically when the tape is inserted.
- Select OFF if you *do not* want a tape with its safety tab removed to start playing automatically.

AUTO TV/VCR

This feature controls whether the TV/VCR switch changes automatically to the VCR mode, when the VCR is turned on. Press 3 to switch between ON and OFF.

- Select ON if you want the VCR to switch to the VCR mode when the VCR is turned on or a cassette is inserted. *This only applies if you connect the IN FROM ANT and OUT TO TV jacks of your VCR and TV and watch your VCR on channel 3 or 4 of your TV.*
- Select OFF if you want the VCR to remain in the TV mode. This is useful if you watch your VCR on the TV's video input and you don't want your antenna/cable signal interrupted by the VCR.

Auto TV/VCR

Pressing TV•VCR will still switch between the VCR and TV mode.

VCR mode: VCR indicator in the display panel lights.

TV mode: VCR indicator turns off.

SETTING UP THE VCR

FRONT PANEL (VCR DISPLAY)

You can change the brightness level of the fluorescent display panel on the front of the VCR. Press 4 to switch between the options.

- AUTO brightens the display when the VCR is on and dims the display when the VCR is off.
- BRIGHT keeps the display bright.
- DIM keeps the display at a low brightness level.

VCR BASICS

LEARN THE BASICS TO GET YOU STARTED

These VCR basics should be enough for you to begin enjoying your VCR. Learning the remote control functions, playing a recorded tape, and recording a program should do just that.

However, there are other features that enhance the enjoyment of your VCR, but they aren't necessary to get you started. If you want to learn more about your VCR, just keep reading.

1 FIRST THINGS FIRST



2 SETTING UP THE VCR



3 VCR BASICS



4 RECORDING



5 PROGRAMMING THE REMOTE



6 OTHER FEATURES



7 CONNECTIONS

VCR Basics tells you what you need to know in order to watch a movie or tape your favorite show.

VCR BASICS

REMOTE BUTTONS

The remote control is capable of controlling your VCR and many brands of televisions. If you have an RCA, ProScan, or GE TV, you may be able to control it without having to program the remote.

COMPONENT BUTTONS

OFF Turns off VCR when remote is set to control the VCR. Also turns some compatible components on and off.

TV Turns on a compatible RCA, ProScan, or GE TV and sets the remote to control the TV. Also used with the OFF button to turn on a different brand of TV (if programmed) and sets the remote to control the TV.

VCR Turns on a compatible RCA, ProScan, or GE VCR and sets the remote to control the VCR.

VCR FUNCTION BUTTONS

CHAN Up or Down Selects next higher or lower channel in the VCR's channel memory.

CLEAR Resets time counter to 0:00:00. Allows you to change entries when setting the clock or a timer recording.

F.ADV Lets you view one frame with each press of the button when tape is in pause.

FORWARD Fast forwards the tape when the VCR is stopped. Searches forward through a tape during playback. Starts slow-motion playback when tape is paused and increases speed of slow-motion playback

GO BACK Switches between two channels. Select one channel and then select another using the number buttons. Press GO BACK to switch between the two channels. In menu mode, press to go back to previous menu.

INFO Shows the status displays on the TV screen.

INPUT Selects between the line input and the VCR's tuner. Line input refers to the signal coming from the component connected to the audio/video input jacks on the back of the VCR.

MENU Brings up VCR MAIN MENU on the TV screen. Used to select a menu item or exit a menu.

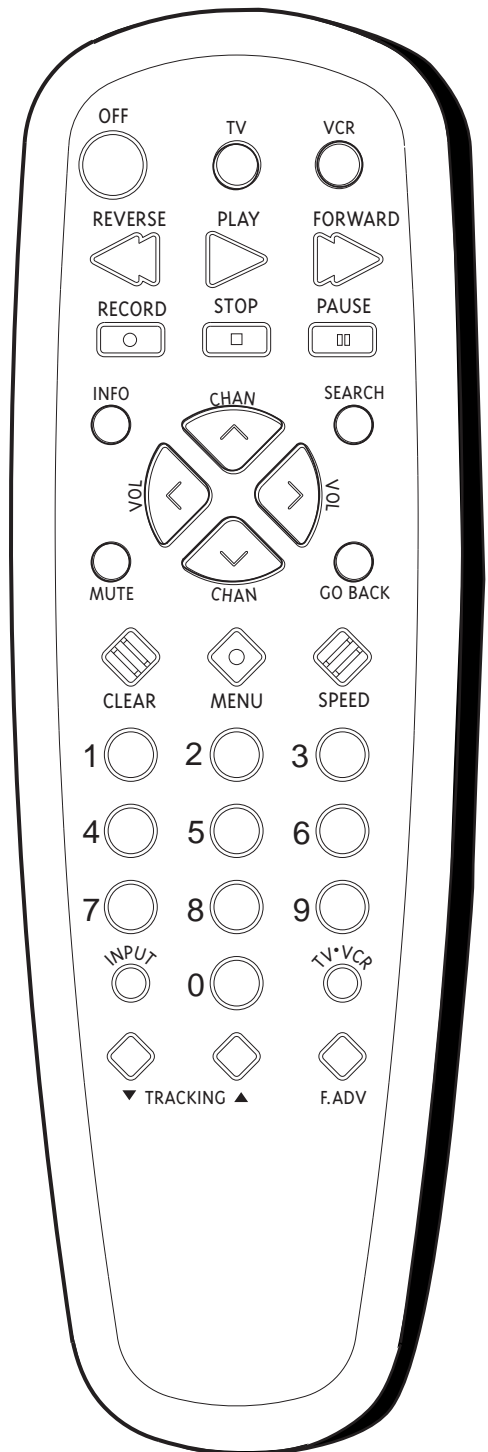

VCR BASICS

Numbers (0 through 9) Select a channel up to 99 by pressing two numbers. Select a cable channel over 99 by pressing and holding 1 until 1 -- appears on the screen. Then press the other two numbers.

OFF Turns off the VCR when the remote is set to control the VCR. Turns off other components if remote is programmed.

PAUSE Pauses playback or recording. Press PAUSE again to return to playback or recording.

PLAY Plays a tape.

RECORD Starts VCR recording. Also used for express recording.

REVERSE Rewinds the tape when the VCR is stopped. Searches backward through a tape during playback. Starts slow-motion playback when tape is paused and decreases speed of slow-motion playback.

SEARCH Displays Index, and Go-To Search menus on TV screen when VCR is stopped. Advances the tape 30 seconds of recorded material during playback.

SPEED Selects a recording speed (SP or SLP).

STOP Stops the current VCR function such as record, playback, rewind, or fast forward.

TRACKING Up or Down Lets you manually reduce the streaks that may appear on the picture during play, slow motion, or pause. Reduces picture "jitter" during stop-action playback.

TV•VCR Switches the picture signal so that it either comes from the VCR or cable/antenna system.

TV FUNCTION BUTTONS

CHAN Up or Down Selects next higher or lower channel in the TV's channel memory.

CLEAR Removes menus or status displays from the screen.

GO BACK Switches between two channels. Select one channel and then select another using the number buttons. Press GO BACK to switch between the two channels.

INFO Shows the TV's status displays on the TV screen.

MUTE Reduces volume to minimum level.

TV Buttons

The TV buttons may not control all features of all models of RCA, ProScan, and GE TVs.

VCR BASICS

Numbers (0 through 9) Select a channel up to 99 by pressing two numbers. Select a cable channel over 99 by pressing and holding 1 until 1 -- appears on the screen. Then press the other two numbers.

OFF Turns the TV off.

VOL Up and Down Raises and lowers sound of TV.

PLAYING A TAPE

1. Tune the TV to your VCR viewing channel (3, 4, or TV's video input).
2. Insert a tape in the VCR.

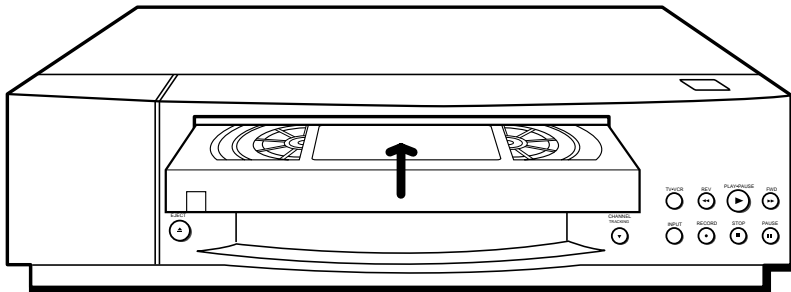

If the Auto Play feature is set to ON, the tape automatically begins playback (if the safety tab on the cassette is removed).

- Press FORWARD or REVERSE to position the tape.
- Press PLAY (if necessary) to begin tape play.
- Press PAUSE for stop action.
- Press TRACKING up or down to remove any streaks from the picture, if necessary.
- Press STOP to stop playback.

AUTOMATIC REWIND

The VCR automatically rewinds the tape if it reaches the end of the tape during playback. While rewinding, you can press POWER on the VCR (OFF on the remote) and the VCR will turn off after rewinding.

Pause

If you pause, the VCR automatically switches from pause to stop after a few minutes to reduce tape wear.

Automatic Tracking

The VCR has automatic tracking which adjusts the picture when playing back a tape recorded on another VCR. Automatic tracking is turned on whenever a tape is inserted or the VCR's power is turned on.

VCR BASICS

TAPE EJECT

Press EJECT on the VCR when it is stopped to eject the tape.

RECORDING

If you want to record something that you're watching, you can use basic recording.

1. Set the tape speed by pressing the SPEED button on the remote (see margin note for information about tape speed settings).
2. Press the RECORD button to begin recording.
3. Press STOP to stop recording.

If you just want to pause the recording for a short time (like during a commercial), press PAUSE instead of STOP.

CHECK THE SAFETY TAB

No matter which recording option you use, you need to make sure there is a tape in the VCR, and that the tape's safety tab is in place. You cannot record on a tape with the safety tab removed.

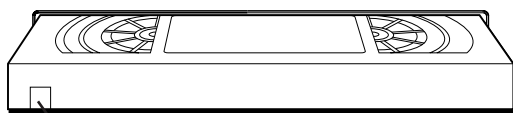

Safety Tab

If the safety tab is removed and you want to record over it, simply cover the hole with vinyl tape.

Tape Speeds

SP (Standard Play)

Gives the best quality recording, but fewer programs can be recorded on the tape. Special effects such as pause, slow motion, picture search, and frame advance work well when you play back tapes recorded in this speed.

LP (Long Play)

Gives twice the recording time of tapes recorded in LP. If you plan on using special effects during playback, LP is not recommended.

SLP (Super Long Play)

Gives three times the recording time of tapes recorded in SP. Special effects such as pause, slow motion, picture search, and frame advance work well when you play back tapes recorded in this speed.

	Recording Time	
Cassette	SP	SLP
T-120	2Hr	6Hr
T-160	2Hr 40Min	8Hr

RECORDING

SEVERAL RECORDING OPTIONS

Now that you've gone through the necessary steps to operate your VCR, I'll explain the different recording features that are available to suit your needs.

Recording Features:

- Recording (explained in *VCR Basics* section)
- Express Recording
- Timer Recording
- Timer Recording with VCR Plus+
- Broadcast Stereo or Second Audio Program (SAP)
- Audio Only Recording
- Copying and Editing Tapes

1 FIRST THINGS FIRST



2 SETTING UP THE VCR



3 VCR BASICS



4 RECORDING



5 PROGRAMMING THE REMOTE



6 OTHER FEATURES



7 CONNECTIONS

RECORDING

RECORDING FEATURES

There are four ways to record programs:

- **Recording** lets you press one button to start recording a program. (See *VCR Basics* section.)
- **Express Recording** lets you start recording a program you are watching, and then set the VCR to automatically stop recording after a designated period of time.
- **Timer Recording** lets you program the VCR to automatically start and stop recording at a predetermined time.
- **Timer Recording with VCR Plus** lets you program the VCR just by entering a PlusCode number found in some TV guides.

EXPRESS RECORDING (XPR)

Use express recording when you want to quickly record the remaining portion of the program you are watching.

1. Set the tape speed by pressing the SPEED button on the remote.
2. Press the RECORD button to begin recording.
3. Repeatedly press the RECORD button to set up the recording duration.

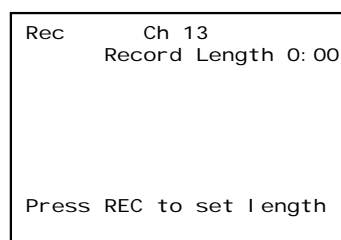
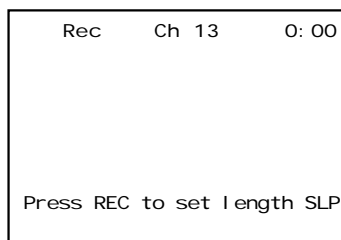

Each time you press the RECORD button, you increase the recording time (up to 4 hours).

The VCR continues to record for the amount of time you indicate, and then automatically turns off.

Express Recording

Express recording is a great way to tape the last quarter of the game, or the last part of a movie when you have to leave.

To stop an express recording, press and hold STOP for a few seconds.

RECORDING

TIMER RECORDING

You can set up as many as eight timer recording programs.

1. Press MENU to display the VCR MAIN MENU.

```
VCR MAIN MENU
1 VCR Plus+
2 Timer Recordings
3 Time
4 Channels
5 Preferences
6 Audio
7 Language
0 Exit
```

2. Press 2 to display the TIMER RECORDINGS menu.

```
TIMER RECORDINGS
1 Create a New Program
2 Review Existing Progs.
3 Use VCR Plus+ Code
0 Exit
```

3. Press 1 to Create a New Program.

```
How often should this
program record?
1 One Time
2 Daily (every day)
3 Weekdays (M-F)
4 Weekly (Once per week)
0 Cancel
```

4. Select how often you want the program to record.

```
Program 1 (One Time)
Channel --
Start Time --:--
End Time --:--
Start Date --/--/--
Tape Speed SLP
Press MENU to cancel
```

5. Enter the data for the program with the number buttons.

The data includes the channel number (press INPUT to select the line input), start time including AM or PM, and end time. The start date is automatically entered based on the VCR clock. Both the date and speed can be changed.

Timer Recording Information

Clock must be set correctly.

Insert a tape with the safety tab in place and enough tape to record the program.

The output of your cable box appears in the Channel item of the timer recording menu if you've set up the VCR for a cable box for all channels.

PROGRAMS OVERLAP appears if you have entered two programs where the times overlap.

The TIMER indicator appears in the display when you turn off the VCR and a timer recording has been set. It flashes if there is no tape in the VCR.

RECORDING

- Review the information to make sure it is correct, and then press MENU to save.

```

Program 1 (One Time)
Channel      03 Cable
Start Time  08:00 PM
End Time    09:30 PM
Start Date  10/24/97 Fri
Tape Speed  SLP
            1=SP
Press CLEAR to correct
Press MENU to save
    
```

```

Program 1 has been saved

Remember to insert a
recordable tape and
turn the VCR off before
the program start time.

Remember to leave your
cable box on and tuned
to the desired channel.
    
```

TIMER RECORDING WITH VCR PLUS+

You can use VCR Plus+ to simplify timer programming if you have cable TV and don't receive all channels through a cable box, have a cable box the VCR can control, or if you get your TV signal off-air.

Setting Up the Channel List

If you did not set up the VCR Plus+ channel list, you can do it now.

- Display the CHANNELS menu from the VCR MAIN MENU.
- Display the VCR Plus+ Channel List menu.
- Go to *Setting Up Your VCR* if you need more information on setting up your VCR Plus+ channel list.

Using VCR Plus+

- Press MENU to bring up the VCR MAIN MENU.

```

VCR MAIN MENU
1 VCR Plus+
2 Timer Recordings
3 Time
4 Channels
5 Preferences
6 Audio
7 Language
0 Exit
    
```

- Press 1 to display the VCR PLUS+ menu.

```

VCR PLUS+

Enter PlusCode Number
(From TV Listing)
-

Press MENU to cancel
    
```

```

VCR MAIN MENU
1 VCR Plus+
2 Timer Recordings
3 Time
4 Channels

CHANNELS
1 Auto Channel Search
2 Add/Remove Channels
3 Signal Type: CABLE
4 VCR Plus+ Channel List

VCR+ Channel My Channel
5          46
4          --
3 -> -> -> 23
2          --
1          --

Use CH+/- to select
Press 0-9 to change
Press MENU to save
    
```

VCR Plus+ and PlusCode are registered trademarks of Gemstar Development Corporation.

RECORDING

3. Enter the VCR PlusCode shown in your local television programming guide.

```
VCR PLUS+
Enter PlusCode Number
  (from TV listing)
  12876

Press CLEAR to correct
Press MENU when done
```

4. Press MENU to enter the VCR PlusCode number.

```
How often should this
program record?

1 One Time
2 Daily (every day)
3 Weekdays (M-F)
4 Weekly (Once per week)

0 Cancel
```

5. Indicate how often you want the program to be recorded.

```
Program 1 (One Time)

Channel      03 CABLE
Start Time   08:00 PM
End Time     09:30 PM
Start Date   10/24/97 Fri
Tape Speed   SLP

Press CLEAR to adjust
Press MENU to save
```

6. Change the speed with the SPEED button on the remote or the program end time with the CLEAR button on the remote (if necessary).

Changing the end time comes in handy when you are recording a program such as a sporting event that may exceed the scheduled broadcast time.

7. Press MENU to save the program.

```
Program 1 has been saved

Remember to insert a
recordable tape and
turn the VCR off before
the program start time.

Remember to leave your
cable box on and tuned
to the desired channel.
```

VCR Plus+ Recording

Clock must be set correctly.

Insert a tape with the safety tab in place and enough tape to record the program.

The output of your cable box appears in the Channel item of the timer recording menu if you've set up the VCR for a cable box for all channels. The correct channel and start & stop time will also appear if the VCR is set up to control the cable box.

UNRECOGNIZED NUMBER... PLEASE RE-ENTER appears when the VCR does not recognize the PlusCode number.

PROGRAMS OVERLAP appears if you have entered two programs where the times overlap.

The **TIMER** indicator appears in the display when you turn off the VCR and a timer recording has been set. It flashes if there is no tape in the VCR.

For a cable box, turn it on and tune it to the channel you want to record before the recording is to begin.

RECORDING

STOPPING A TIMER RECORDING

To stop or cancel a timer recording in progress (even an express recording):

- Press and hold the STOP button for a few seconds.

REVIEWING AND CLEARING PROGRAMS

To review programs that you have already set up:

1. Press 2 when the VCR MAIN MENU is displayed to display the TIMER RECORDINGS menu.

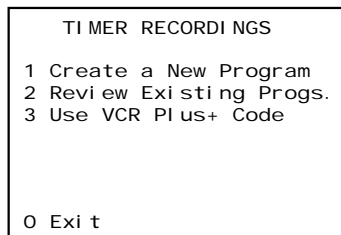

2. Press 2 to display the Review Existing Progs. screen.

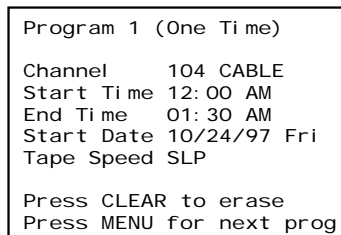

3. Press CLEAR to erase or MENU to see the next program.

RECORDING BROADCAST STEREO TV OR SAP (SECOND AUDIO PROGRAM)

Some TV programs are broadcast with stereo audio or SAP (Second Audio Program).

1. Turn on the TV and tune it to the VCR viewing channel (either 3, 4, or TV's video input).
2. Insert a tape with safety tab in place.

RECORDING

3. If your VCR viewing channel is 3 or 4, make sure the VCR indicator appears in the VCR's display panel. If not, press TV•VCR to turn it on.
4. Use the SPEED button on the remote to select a recording speed. The tape speed indicator appears on the TV screen.
5. Select the channel or line input to be recorded.
6. Set the Reception: STEREO/MONO/SAP feature for the type of audio you want to record. See *Other Features* section.

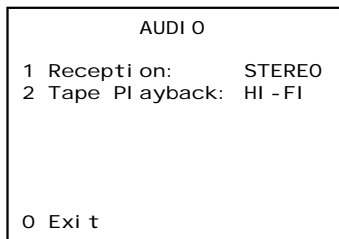

7. Press RECORD to start recording.
8. Press STOP when you are finished.

RECORDING AUDIO ONLY

You can record audio only from another audio source connected to the AUDIO IN (R and L) jacks on the back of the VCR.

1. Press the INPUT button on the remote to select the line input (LINE).

The VCR will record audio from the audio equipment connected to the AUDIO IN jacks.

2. Use SPEED on the remote to select the recording speed.
3. Start audio source playing and press RECORD to begin recording.
4. Press STOP when you are finished.

Playing Back Audio Only

To get stereo sound, connect the AUDIO OUT jacks of the VCR to the appropriate input on your amplifier or receiver. Do not use the phono input. Refer to your amplifier or receiver user's guide.

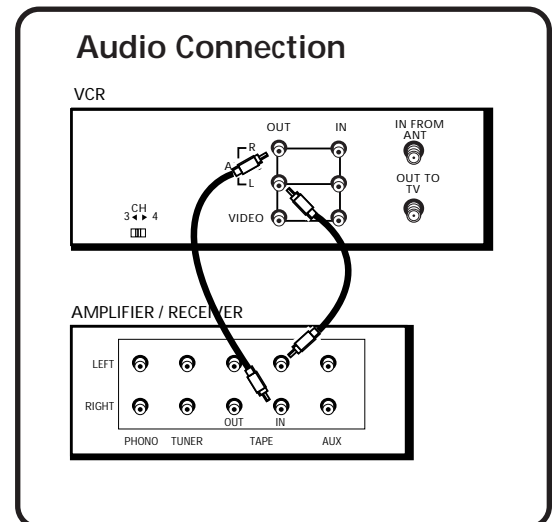

RECORDING

USING TWO VCERS FOR COPYING AND EDITING TAPES

Use one VCR as the *playback VCR* and the other as the *recording VCR*.

1. Turn on the TV and VCRs.
2. Tune the TV to the VCR viewing channel (either 3, 4, or TV's video input).
3. If you connected your VCR using the IN FROM ANT and OUT TO TV jacks, tune *recording VCR* to channel 3 or 4—the one selected on the back of the *playback VCR*.

If you have connected your VCR using the audio/video jacks, make sure you select the line input on the *recording VCR*.

4. Insert the tape you want to copy into the *playback VCR*. Insert a blank tape with safety tab in place into the *recording VCR*.
5. Press PLAY on the *playback VCR* to begin playback. When you reach the point on the tape or program where you want to begin copying, press PAUSE again. You may need to adjust the tracking.
6. Press the RECORD button, then press PAUSE, on the *recording VCR*.
7. Press the PAUSE buttons on *both VCRs* at the same time to begin copying the tape.
8. To edit segments that you do not want to copy:
 - Press PAUSE on *recording VCR* to pause copying.
 - Locate the next segment you want to copy on *playback VCR* by using FWD, REV, and PLAY, and then press PAUSE.
 - Press PAUSE on *both VCRs* at the same time to resume copying.
9. Press STOP on *both VCRs* when you are finished.

Caution:

The unauthorized recording of television programs or other copyrighted materials may infringe the rights of others.

Two VCR Connection

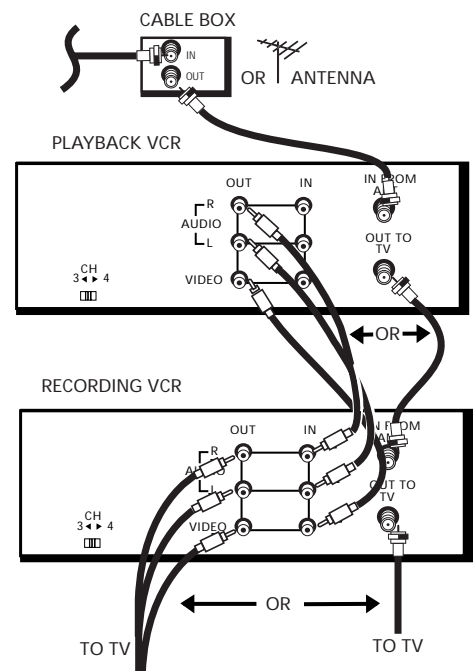

PROGRAMMING THE REMOTE

CONTROL YOUR TELEVISION

The remote may also operate your TV. Initially, it is programmed to control RCA, GE, and ProScan models. Other manufacturers' brands need to be programmed.

1 FIRST THINGS FIRST



2 SETTING UP THE VCR



3 VCR BASICS



4 RECORDING



5 PROGRAMMING THE REMOTE



6 OTHER FEATURES



7 CONNECTIONS

PROGRAMMING THE REMOTE

USING THE REMOTE WITH A TV

Your remote can control most RCA, ProScan, and GE TVs. To use the remote with other manufacturer's brands, it must be programmed. If the TV does not turn on when you press the TV button, the remote needs to be programmed.

Follow these steps to program the remote to control your particular TV:

1. Turn on the TV.
2. Find your TV brand and code number(s) on the code list.
3. Press and hold the TV button on the remote.
4. Enter the code from the code list.
5. Release TV, and then press CHAN up or down. If the TV responds to the remote commands, the remote is programmed.
6. If the TV does not respond, repeat these steps using the next code in the list.

OPERATE THE TV

After you set up the remote, see which buttons operate your TV.

1. Point the remote at the TV, and press the TV button.
If the TV does not turn on, press the TV button and then press the OFF button.
2. You may want to experiment to see which buttons operate your TV. Try pressing buttons, such as VOL and MUTE. See "TV Function Buttons" in the *VCR Basic Section* for details.

TV Codes

Akai	03	NAD	07
AOC	06,12	NEC	06
Candle	06	Panasonic	04,08,11
Citizen	06	Philco	04,06,12
Colortyme	06	Philips	03,04,06,12
Concerto	06	Pioneer	06
Curtis Mathes	01,06	Portland	06,12
Daewoo	06,12	ProScan	01
Daytron	06	Proton	06
Electrohome	06,12	Quasar	11
Emerson	06	Radio Shack	01,05,13
Envision	05,06	RCA	01,06,12
Fisher	05,08	Realistic	05
GE	00,01,06,11	Sampo	06
Goldstar	06,12	Samsung	06,09,12
Hallmark	06	Sanyo	05,08
Hitachi	06,14	Sears	01,05,06,07,08,10,12
Infinity	04	Sharp	06,13
JC Penney	00,01,06,09,12	Sony	03
JBL	04	Soundesign	06
Jensen	06	Sylvania	04,06,12
JVC	10,11	Technics	11
Kawasho	03,06	Techwood	06
Kenwood	06,12	Teknika	06
Loewe	04	TMK	06
Luxman	06	Toshiba	05,07,08,09
LXI	04,05,07	Universal	00
Magnavox	04,06,12	Victor	10
Marantz	04,06	Wards	00,01,04,06,12,13
MGA	06,12	Yamaha	12
Mitsubishi	06,12	Zenith	02
MTC	06		

This remote may not operate all models of the brands that are shown.

Note the difference between the TV and VCR on-screen displays to see which one the remote is operating.

OTHER FEATURES

FEATURES TO ENHANCE VCR OPERATION

- COMMERCIAL▶▶ADVANCE
- MOVIE▶▶ADVANCE
- Picture Search Options
- Tracking
- Time Counter
- On-Screen Displays
- Audio Reception
- Audio Tape Playback

1 FIRST THINGS FIRST



2 SETTING UP THE VCR



3 VCR BASICS



4 RECORDING



5 PROGRAMMING THE REMOTE



6 OTHER FEATURES



7 CONNECTIONS

OTHER FEATURES

COMMERCIAL▶▶ADVANCE

COMMERCIAL ▶▶ADVANCE is a patented technology that detects and marks most commercials on your tape for any recording that is more than 15 minutes long. After recording, the VCR rewinds the tape to the beginning of the recording and determines where the commercials are located. It then marks the beginning and end of the detected commercial segments and when finished returns the tape to the end of the recording. **It does not erase the commercials from the tape.**

During playback, the VCR automatically skips the detected commercial segments, or you can choose to manually skip them. This feature reduces three minutes of commercials to approximately 8-12 seconds of fast forwarding in the SLP speed. You can select a background display of blue or see the video as the commercials are skipped.

Because television signals do not indicate where commercials are located, this feature finds and marks them through a set of formulas based on how television is broadcast today. Since television stations broadcast differently and insert their own commercials, you may experience some variations in this feature's effectiveness. Station promotions, identifications, and announcements are not considered commercials—but might be skipped. For more information—see *Questions and Answers About COMMERCIAL ▶▶ADVANCE* in the *References* section. All of the COMMERCIAL ▶▶ADVANCE features are accessed through the COMMERCIAL ADVANCE menu.

1. Press MENU to display the VCR MAIN MENU.

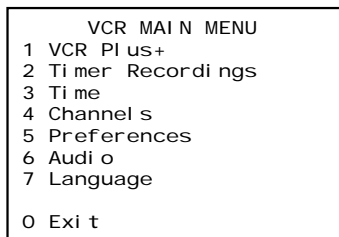

COMMERCIAL ▶▶ADVANCE is a registered trademark in the U.S. of SRT, Inc.

OTHER FEATURES

2. Press 5 to display the PREFERENCES menu.

```
PREFERENCES
1 Remote Control: VCR1
2 Auto Play:      ON
3 Auto TV/VCR:   ON
4 Front Panel    AUTO
5 Commercial Advance

0 Exit
```

3. Press 5 to display the COMMERCIAL ADVANCE menu.

```
COMMERCIAL ADVANCE
1 Marking:        ON
2 Playback:       AUTO
3 Display:        BLUE
4 Mark an unmarked tape

0 Exit
```

Now, you can select one of the COMMERCIAL L▶▶ADVANCE features.

COMMERCIAL▶▶ADVANCE Marking

Press 1 to turn commercial Marking ON or OFF .

- Select ON, and the VCR will mark commercials within approximately 30 seconds for the following types of recording:
 - **Timer, Timer with VCR Plus+, or Express Recording**
The VCR automatically marks the commercials after the power is turned off.
 - **Recording** When you stop the recording, the VCR prompts you to mark the commercials.

```
The VCR is waiting to
mark commercials in the
program you recorded.

1 Mark them now
2 Mark them later
3 Don't mark commercials

The VCR will begin
marking in 30 seconds. . .
```

- Select OFF and the VCR will not mark the commercials.

OTHER FEATURES

COMMERCIAL ►► ADVANCE Playback

Press 2 to switch between Playback: AUTO and MANUAL.

- Select AUTO to have the VCR automatically advance through the blocks of marked commercials.

It works with most 30, 45, and 60-second commercials.

A commercial group starting within the first two minutes or last two minutes of a recording will not be automatically skipped.

A commercial will not be skipped if the recording starts in the middle of a commercial segment, one isolated commercial is shown without others, or a commercial is longer than one minute. Press FWD to scan through the commercial.

Part of a recorded program may be skipped if the program segment is between commercials and less than one minute or there are frequent dark and quiet scenes. If part of the program is skipped, rewind the tape to the beginning of the skipped program segment and press PLAY.

- Select MANUAL and the VCR won't advance through the blocks of marked commercials until you press SEARCH.

If you press SEARCH during playback of material other than commercials, the VCR advances to the end of the next "marked" commercial block and resumes playback.

The VCR resumes playback when it reaches the end of the marked commercials.

COMMERCIAL ►► ADVANCE Display

Press 3 to switch between Display: BLUE or VIDEO.

- Select BLUE to display a BLUE background when the VCR advances through the block of marked commercials.
- Select VIDEO to display the recorded video when the VCR advances through the block of marked commercials.

Marking an Unmarked Tape

This feature allows you to mark an existing tape turning it into a COMMERCIAL ►► ADVANCE tape. The VCR will play the tape and then mark the commercial segments it finds.

OTHER FEATURES

1. Insert a tape that has been previously recorded.
2. Press 4 to select the Mark an unmarked tape feature.
3. Position the tape where you want the marking to start using PLAY, FWD, and REV buttons.

Set the tape to the point at which you want to start marking.

When the tape is ready, press MENU to begin.

Press CLEAR to cancel

4. Press MENU to begin the marking process. The VCR will play the tape until it finds six seconds (or more) of blank tape or until the tape reaches the end. It will then rewind the tape to the starting point you set and begin marking the commercial segments.

When marking an unmarked tape with **COMMERCIAL▶▶ADVANCE**, the VCR plays the tape at normal speed, so this process may take some time.

MOVIE▶▶ADVANCE

MOVIE▶▶ADVANCE helps you locate certain parts of prerecorded movies (rented or purchased). The feature works in two ways: 1) you can go to the beginning of the movie or 2) you can skip from one preview to the next.

MOVIE▶▶ADVANCE works only on cassettes recorded in the SP speed with the safety tab removed.

1. To select MOVIE▶▶ADVANCE, insert a tape with the safety tab removed and press SEARCH. The following menu appears.

What type of tape is this?

- 1 Purchased/Rented Movie
- 2 Home Recording
- 3 Other

Press CLEAR to cancel

2. Press 1 if the tape is a purchased or rented movie, press 2 if it's a recording made at home, or press 3 if it is something else, you don't know, or you do not want to select MOVIE▶▶ADVANCE.

MOVIE▶▶ADVANCE is a trademark of SRT, Inc.

MOVIE▶▶ADVANCE works only on cassettes recorded in the SP speed with the safety tab removed.

OTHER FEATURES

Pressing 2 or 3 gives the same response and takes you to a different search feature. If you accidentally make a wrong selection, press GO BACK to return to this screen.

If you press 1, the MOVIE ADVANCE menu appears.

```
MOVIE ADVANCE
Would you like to go to
the start of the movie
or to the next preview?

1 Go to movie
2 Go to preview

Press CLEAR to cancel
```

3. Press 1 to advance directly to the beginning of the movie or press 2 to view the first (next) preview.
- Press 1 to Go to movie. The following screen appears with a blue background.

```
MOVIE ADVANCE
Searching for start
of movie

Press STOP to cancel
```

When the movie is found, the following screen is displayed.

```
MOVIE ADVANCE
The movie is ready.
Press PLAY to start.

Press STOP to cancel
```

This display will time out after a few minutes and the VCR will enter the stop mode.

- Press 2 to Go to preview. The following screen appears with a video background.

Preview Search Note

Any time during the preview search mode, pressing SEARCH will reverse the search direction.

OTHER FEATURES

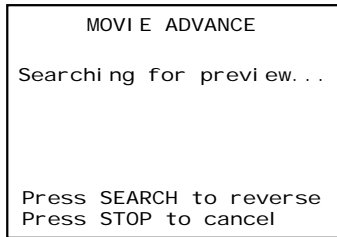

When a preview is detected, the VCR cues it and begins playing.

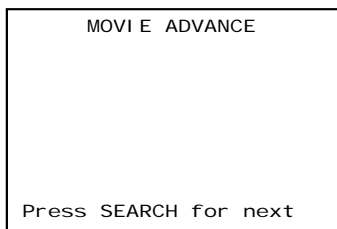

PICTURE SEARCH OPTIONS

The most basic way to search during playback is using the FORWARD (FWD) and REVERSE (REV) buttons. This section contains several other options available for searching a tape.

FORWARD AND REVERSE SEARCH

You can search a tape during playback. Sound is turned off during picture search. Search works best for tapes recorded at the SP or SLP speed.

1. Press FORWARD (FWD) to search forward or REVERSE (REV) to search in reverse.
2. Press FORWARD or REVERSE again or press PLAY to return to normal playback.

Insert Tape

Don't forget to insert a recorded tape when using the search features.

OTHER FEATURES

SLOW MOTION

You can view a tape in slow motion from the play-pause mode. Slow motion works best for tapes recorded at the SP or SLP speed.

1. Press PAUSE to “freeze” the action. Then press FOR WARD (FWD) or REVERSE (REV) to begin slow-motion playback.
2. Press FOR WARD to increase or REVERSE to decrease the speed of the slow-motion playback.
3. Use TRACKING up or down to remove any streaks from the picture.
4. Press PLAY to return to normal playback.

The VCR switches automatically from slow-motion playback to stop after a few minutes.

FRAME ADVANCE

Frame advance lets you view one-stop action frame after another during playback. Frame advance works best for tapes recorded at the SP or SLP speed.

1. Press PAUSE to “freeze” the action.
2. Press F.ADV each time you want to view a frame of the scene.
3. Press PAUSE or PLAY to return to normal playback.

INDEX SEARCH

The VCR has a “VHS Index Search System” that automatically records an index mark on the tape every time you start a recording. During playback you can locate the program you want to play by the number of index marks or by scanning. The VCR will search forward or reverse from the location you are on the tape.

To Search:

1. Press STOP.
2. Press SEARCH on the remote until the INDEX SEARCH menu appears on the TV screen.

INDEX SEARCH
Press REV OR FWD to begin scanning OR enter a specific index number
--
Press SEARCH to exit

OTHER FEATURES

3. If you want to search through a certain number of index marks, press two number buttons to enter the number of marks you want to search. Press CLEAR on the remote to correct an entry.
4. Press FORWARD (FWD) to search forward or REVERSE (REV) to search in reverse. The VCR will locate your index mark and begin playback. If you did not enter a specific index number, the VCR will locate the next index mark and begin playback.
5. Press STOP to stop index searching.

Some index marks may be missed by the VCR:

- A mark too close to your location on the tape.
- The mark at the beginning of a recorded segment of five minutes or less.
- The first index mark on the tape when you start at the beginning of the tape.

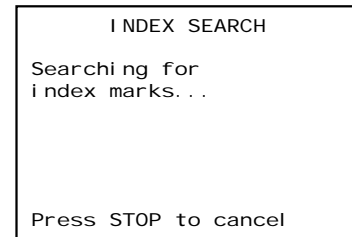
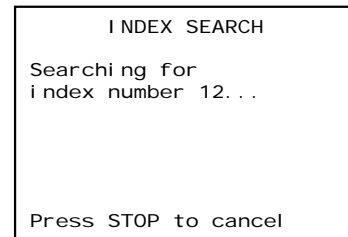

GO-TO SEARCH

The Go-To search feature enables the VCR to quickly locate a counter reading anywhere on the tape. When the VCR locates the counter reading, it will begin playback.

1. Press STOP.
2. Press SEARCH on the remote until the GO-TO SEARCH menu appears on the screen.
3. Press number buttons to enter the hour(s) and/or minutes of the counter reading you want the VCR to "go to". Press CLEAR on the remote to correct an entry.
4. Press FORWARD (FWD) to search forward or REVERSE (REV) to search in reverse.
5. Press STOP to stop Go-To searching.

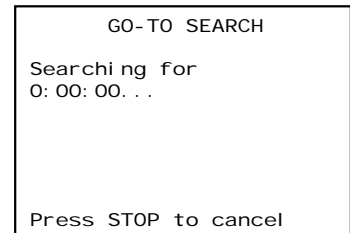
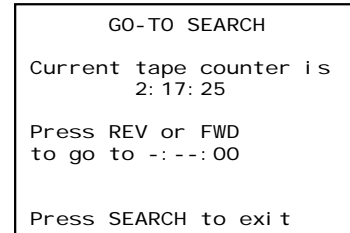

TIME COUNTER

The time counter shows the actual time it takes to record a program or play back a segment of a recorded tape. It helps locate the beginning or end of programs you taped. The time counter resets to 0:00:00 whenever the tape is ejected from the VCR.

OTHER FEATURES

For example, if you record a 30-minute program at the beginning of the tape and you want to go to the end of that program to begin another recording, you would:

1. Press INFO **twice** on the remote to display the time counter.
2. Press CLEAR to reset the time counter to 0:00:00.
3. Press FOR WARD (FWD) to forward the tape until the time counter reads 0:30:00.
4. Press STOP. This is the approximate end of the program. (You may want to press PLAY to verify.) Now, you can begin recording at this spot.
5. Press INFO to remove the time counter from the screen and return to the normal display mode.

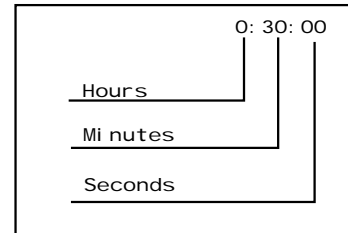

TRACKING

Your VCR has automatic tracking which removes the streaks or snow from the picture. Automatic tracking is activated when you insert a tape or turn on the VCR. Occasionally you may need to manually adjust tracking, especially if the tape was recorded on a different VCR. Just use the TRACKING buttons to remove the streaks or snow. You can also use tracking when you pause a tape to reduce jittering of the picture.

When you manually adjust the picture, automatic tracking is turned off. To turn automatic tracking back on, press both TRACKING buttons on the VCR at the same time, or eject the tape and re-insert it.

Tracking only effects playback—not recording.

ON-SCREEN DISPLAYS

The INFO button shows the status of the VCR (STOP, PLAY, RECORD, etc.), channel number, time counter, date, time, and tape speed on the TV screen. The date and time must be set before they can be displayed.

1. Press INFO to see all of the on-screen displays. These will automatically time out after a few seconds

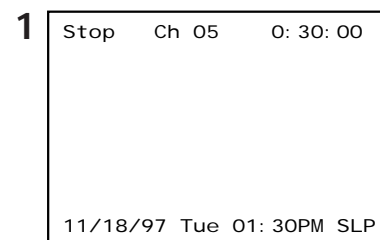

*On-screen display
(times out)*

OTHER FEATURES

2. Press INFO again to have only the time counter remain on the screen. This display does not time out automatically.
3. Pressing INFO a third time disables the on-screen displays. This feature prevents you from accidentally recording on-screen displays while copying tapes.
4. Press INFO to see all of the on-screen displays again.

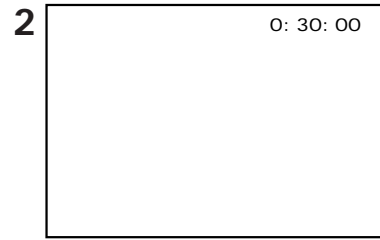

*Time counter only
(does not time out)*



On-screen display off

AUDIO SET-UP FEATURES

The audio set-up features enhance your tape playback and recordings. The features in this section are accessed through the AUDIO menu and are shown in the displays below.

1. Press MENU to display the VCR MAIN MENU.

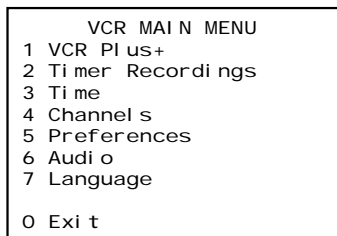

2. Press 6 to display the AUDIO menu.

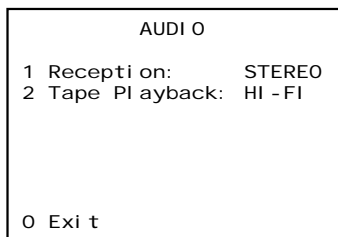

Now you are ready to select an item from the menu to set up.

OTHER FEATURES

RECEPTION

Some TV programs are broadcast with stereo audio or a second audio program (SAP) which offers a second language. The Reception feature lets you select the type of audio you want to record. Press 1 to switch between Reception: STEREO, MONO, and SAP.

- Select STEREO for normal or stereo broadcast TV recording. STEREO indicator appears on the TV screen when the station you are tuned to is broadcasting stereo.
- Select MONO if the stereo signal is weak and the sound is too noisy.
- Select SAP to record a second audio program instead of the normal audio on both the hi-fi and linear tracks. The SAP indicator appears on the TV screen when the station you are tuned to is broadcasting SAP.

TAPE PLAYBACK

The VCR records the same audio on both the Hi-Fi and linear tracks on the tape. Hi-Fi sound is recorded on separate left and right stereo channels. Monaural sound is recorded on the linear track. Press 2 to switch between Tape Playback: HI-FI, LINEAR, and MIX.

To enjoy Hi-Fi sound, connect your VCR to a stereo television or amplifier/receiver using the audio/video jacks. The Tape Playback feature lets you select which audio you play back.

- Select HI-FI to play back sound recorded on the Hi-Fi track and for normal use.
- Select LINEAR to play back the sound recorded on the linear monaural track, such as a second audio program, (SAP) or a dubbed voice-over.
- Select MIX to play back the sound recorded on both the linear track and the Hi-Fi track, sound-on-sound.

CONNECTIONS

THINGS TO KNOW BEFORE CONNECTING COMPONENTS

Protect Your Components from Power Surges

- Connect all components before plugging any power cords into the wall outlet.
- Always turn off the TV and other components before you connect or disconnect any cables.

Position Cables Correctly to Avoid Audio Hum or Interference

- Insert all cable plugs firmly into their jacks.
- Place the audio/video cables to the sides of the TV's back panel instead of straight down the middle after you connect your components.
- Try not to coil any twin-lead cables and keep them away from the audio/video cables as much as possible.
- Make sure all antennas and cables are properly grounded. Refer to the Safety Tips sheet packed with your unit.

Protect Your Components from Overheating

- Do not block ventilation holes in any of the components. Arrange the components so that air can circulate freely.
- Do not stack components.
- Allow adequate ventilation when placing your components in a stand.
- Place an amplifier or satellite receiver on the top shelf of the stand so heated air rising from it will not flow around other components.

1 FIRST THINGS FIRST



2 SETTING UP THE VCR



3 VCR BASICS



4 RECORDING



5 PROGRAMMING THE REMOTE



6 OTHER FEATURES



7 CONNECTIONS

CONNECTIONS

CONNECTING YOUR VCR

Refer to these pages to help you connect your VCR.

JACKS AND CABLES

RF Jacks and Coaxial Cables (F-type)

The RF jacks provide good picture and mono sound quality, and must be used if audio/video connections are not available for your TV.

These jacks are required for antenna or cable-TV connections. The RF jacks on the VCR are labeled IN FROM ANT and OUT TO TV. The coaxial cable supplied with your VCR is used to connect the VCR's OUT TO TV jack and your TV's antenna input.



RF Jack

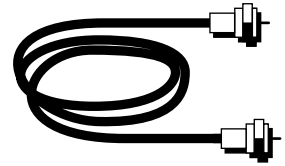

Audio/Video Jacks and Cables (RCA-type)

The audio/video jacks provide very good picture and sound quality, and can be used if your TV has audio/video input jacks.

These jacks must be used for stereo sound. The VCR audio/video jacks are color coded (yellow for video, red for right audio, and white for left audio). If your TV has only one input for audio (mono), you may need a Y-adaptor to hear sound from both channels.



Audio/Video Jack

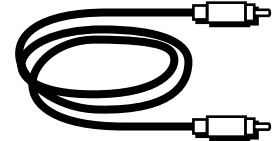

CONNECTIONS

CHOOSING A VCR CONNECTION

There are several different ways to connect your VCR, depending on whether or not you have cable service, and if you have a cable box, and whether some of the channels are scrambled, and maybe you have a satellite receiver along with cable (but no cable box), or a satellite receiver and no cable or...well, you get the picture.

Five connections are described in this section and one of them should provide you with a VCR connection that works.

- TV with RF jack only
- TV with audio/video jacks
- TV with audio/video jacks and cable box to unscramble pay channels only
- TV with RF jack and satellite receiver
- TV with audio/video jacks and satellite receiver

If you need to connect additional components not shown in the diagrams here (and are unsure of how to connect them), refer to the instruction manual that came with that particular component.

ADVANTAGES OF AUDIO/VIDEO CABLE CONNECTIONS

Using a simple coaxial cable connection gives you good picture quality. If your television has audio/video jacks, I highly recommend using them to get even better picture quality and stereo sound when recording and playing back videotapes. These connections give you more convenient operation by not having to share the TV's antenna signal.

DON'T FORGET ABOUT THE AUTO TV/VCR FEATURE

The TV/VCR switch controls whether the picture signal is coming from the VCR or the cable/antenna system.

You can change the setting manually by using the TV•VCR button on the remote or you can set the Auto TV/VCR feature to ON when using only IN FROM ANT and OUT TO TV jacks and OFF when using the AUDIO/VIDEO output jacks—so your TV signal is not interrupted when the VCR is turned on.

CONNECTIONS

TV WITH RF JACK ONLY

This connection assumes:

- You are connecting antenna, cable, or cable box system.
- Your television has only an RF input jack.

This connection provides:

- Mono sound playback from VCR.
- Record one channel while watching another (except when using a cable box for all channels).

To use this connection, you must have:

- (1) coaxial cable for cable or antenna connection; (2) for cable box

To connect:

1. Connect cables as shown.
2. Return to *First Things First*, then follow the steps.

Using This Connection

Tune your TV to channel 3 or 4, whichever one you selected with the 3CH4 switch on the back of the VCR.

Auto TV/VCR Setting:

- Set the Auto TV/VCR feature to ON.

To play a tape:

1. Insert a tape.
2. If necessary, press PLAY.

To record one program and watch another:

1. Begin recording a program using one of the recording features.
2. Press the TV•VCR button, and select a different channel on the TV.

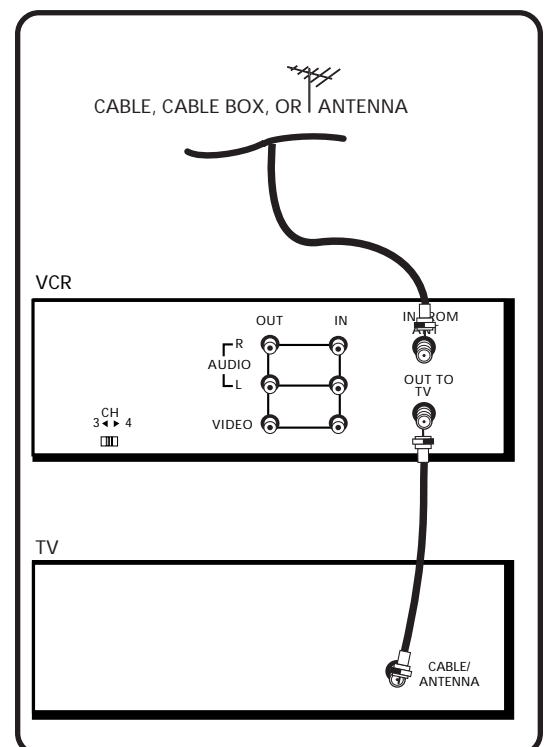

CONNECTIONS

TV WITH AUDIO/VIDEO JACKS

This connection assumes:

- You are connecting an antenna, cable, or cable box system.
- Your television has audio/video jacks.

This connection provides:

- Stereo sound playback from VCR.
- Record one channel while watching another (except when using a cable box for all channels).

To use this connection, you must have:

- (1) coaxial cable for cable/antenna connection; (2) for cable box
- (3) audio/video cables

To connect:

1. Connect cables as shown.
2. Return to *First Things First*, then follow the steps.

Using This Connection

Tune your TV to its video input channel. Use of TV•VCR button is not required.

Auto TV/VCR Setting:

- Set the Auto TV/VCR feature to OFF.

To play a tape:

1. Insert a tape.
2. If necessary, press PLAY.

To record one program and watch another:

1. Begin recording a program using one of the recording features.
2. Select a different channel on the TV.

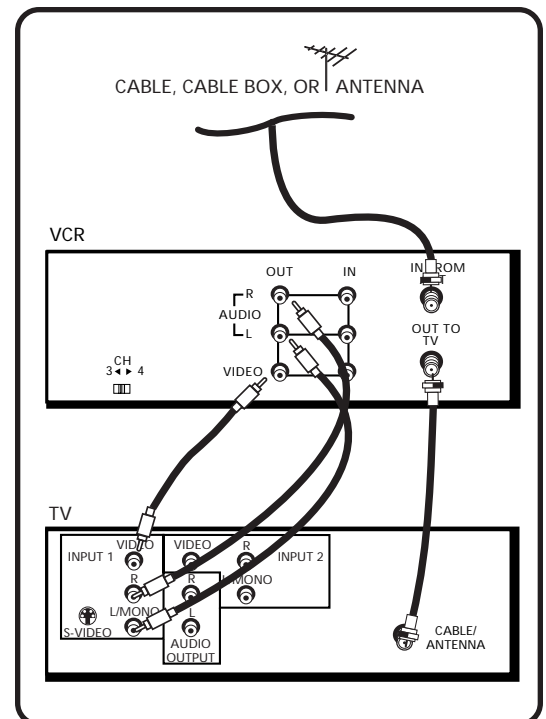

CONNECTIONS

TV WITH AUDIO/VIDEO JACKS AND CABLE BOX TO UNSCRAMBLE PAY CHANNELS ONLY

This connection assumes:

- You are using a cable box only to unscramble premium channels.
- Your TV has audio/video input jacks.

This connection provides:

- Stereo sound playback from VCR.
- Recording a scrambled or unscrambled channel through the cable box while watching an unscrambled channel.

To use this connection, you must have:

- (3) coaxial cables
- (3) audio/video cables
- (1) splitter

To connect:

1. Connect cables as shown.
2. Return to *First Things First*, then follow the steps.

Using This Connection

Tune your TV to its video input channel. Use of TV•VCR button is not required.

Auto TV/VCR Setting:

- Set the Auto TV/VCR feature to OFF.

To play a tape:

1. Insert a tape.
2. If necessary, press PLAY.

To record a scrambled or unscrambled program and watch another unscrambled program:

1. Begin recording a scrambled or unscrambled program through the cable box using one of the recording features.
2. Select an unscrambled channel on the TV.

All scrambled channels must be viewed through the VCR.

For Cable Box Setup, select ALL channels.

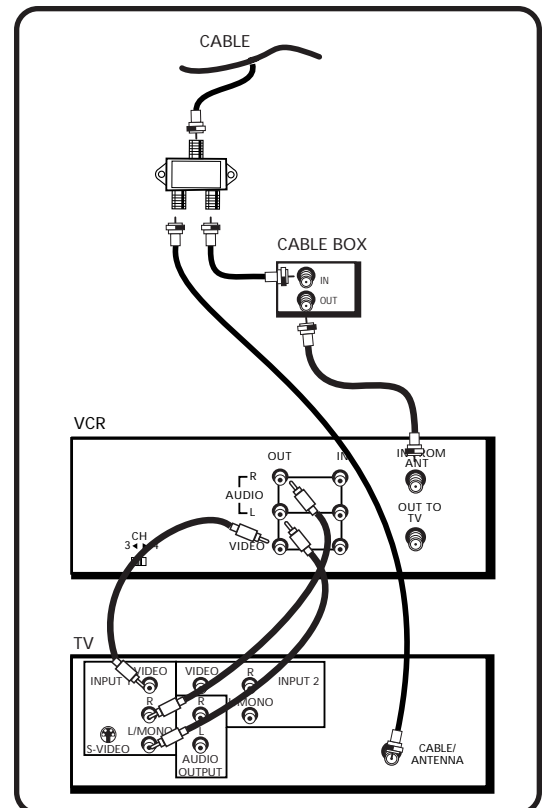

CONNECTIONS

TV WITH RF JACK AND SATELLITE RECEIVER

This connection assumes:

- You have a basic satellite system.
- Your TV does not have audio/video input jacks.

This connection provides:

- Mono sound playback from VCR.
- Recording from a satellite receiver.
- Recording one off-air or cable channel while watching another.

To use this connection, you must have:

- (4) coaxial cables and (3) audio/video cables

To connect:

1. Connect cables as shown.
2. Return to the *First Things First Section*, then follow the steps.

Using This Connection

- Tune your TV to channel 3 or 4, whichever one you selected with the 3CH4 switch on the back of the VCR.
- To record and watch off-air or cable, tune your VCR to channel 3 or 4 whichever one you selected with the CH3/CH4 switch on the back of the receiver. Turn off receiver.
- To watch and/or record from the satellite receiver, tune your VCR to its line input (LINE appears in display).

Auto TV/VCR Setting:

- Set the Auto TV/VCR feature to ON.

To play a tape:

1. Insert a tape.
2. If necessary, press VCR and then PLAY.

To record one off-air or cable program and watch another:

1. Turn off the satellite receiver and begin recording a program using a recording feature.
2. Press TV•VCR and select a different channel on the TV.

To record a satellite receiver program:

1. Turn on the satellite receiver, tune the VCR to its line input, and begin recording a program using a recording feature.

Caution

The unauthorized recording of satellite broadcasts, television programs, or other copyrighted materials may infringe the rights of others.

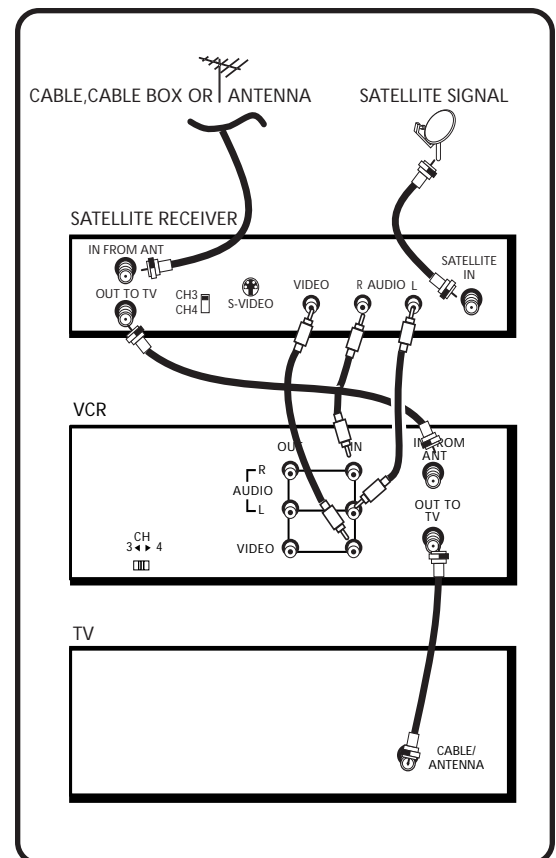

CONNECTIONS

TV WITH AUDIO/VIDEO JACKS AND SATELLITE RECEIVER

This connection assumes:

- You have an advanced satellite system.
- Your TV has audio/video input jacks.

This connection provides:

- Stereo sound playback from VCR.
- Recording from receiver while watching cable or off-air channel.
- Recording one cable or off-air channel while watching another.

To use this connection, you must have:

- (3) coaxial cables and (6) audio/video cables

To connect:

1. Connect cables as shown.
2. Return to the *First Things First*, then follow the steps.

Using This Connection

- To record from the satellite receiver, tune your VCR to its line input (LINE appears in display).
- Tune your TV to its video input to watch the VCR or satellite receiver.

Auto TV/VCR Setting:

- Set the Auto TV/VCR feature to OFF. Use of TV•VCR button is not required.

To play a tape:

1. Insert a tape
2. If necessary, press VCR and then PLAY.

To record one off-air or cable program and watch another:

1. Begin recording a program using a recording feature.
2. Select a different channel on the TV.

To record a satellite receiver program and watch a cable or off-air channel:

1. Turn on satellite receiver, tune the VCR to its line input, and begin recording a program using a recording feature.
2. Select a different channel on the TV.

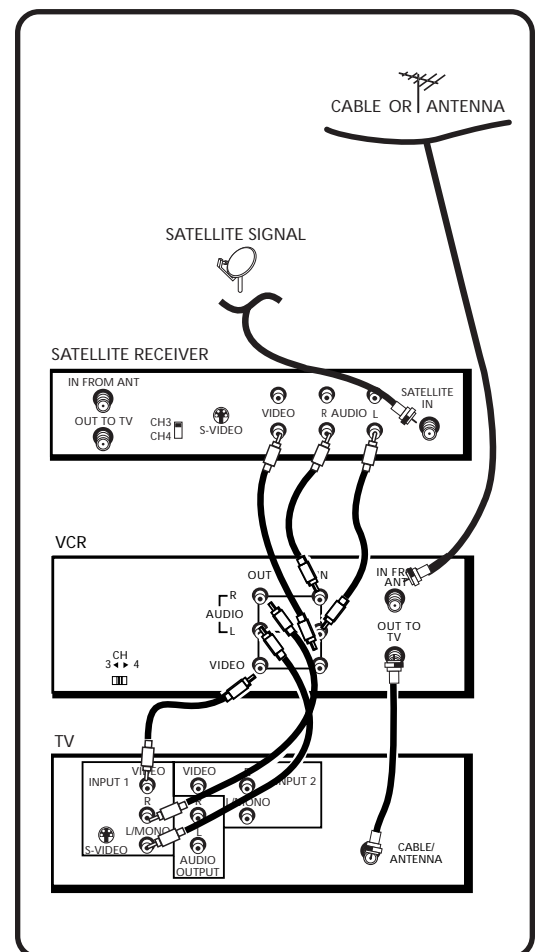

APPENDIX A: REFERENCE

This section gives you some additional information about the VCR, including a description of the unit's controls and display.

You also will find a Troubleshooting Tips section in this Appendix, which might help to resolve some of those simple problems.

Finally, this section contains your warranty information.

APPENDIX A: REFERENCE

FRONT PANEL

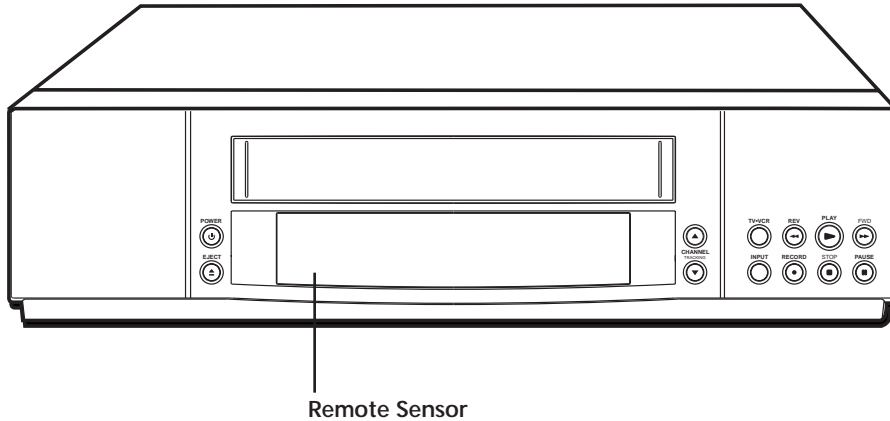

CHANNEL•TRACKING Up or Down Selects next higher or lower channel in the VCR's channel memory. Adjusts tracking when a tape is playing.

EJECT Ejects the tape when the VCR is stopped.

FWD Forwards the tape when the VCR is stopped. Searches the picture forward during playback. Starts slow-motion playback during play-pause and increases slow-motion speed.

INPUT Selects between the line input and VCR's tuner. Line input refers to the signal coming from the component connected to the audio/video input jacks on the back of the VCR.

PAUSE Pauses action for viewing during playback. Pauses recording to prevent recording of unwanted scenes.

PLAY Plays a tape.

POWER Turns the VCR on or off.

RECORD Starts VCR recording. Used for express recording.

Remote Sensor Receives signals from the remote control. Aim the remote at this sensor.

REV Rewinds the tape when the VCR is stopped. Searches the picture in reverse during playback. Starts slow-motion playback during play-pause and decreases slow-motion speed.

STOP Stops the normal functions such as record, playback, rewind, fast-forward, or pause.

TV•VCR Switches the picture signal so that it either comes from the VCR or the TV.

APPENDIX A: REFERENCE

DISPLAY PANEL

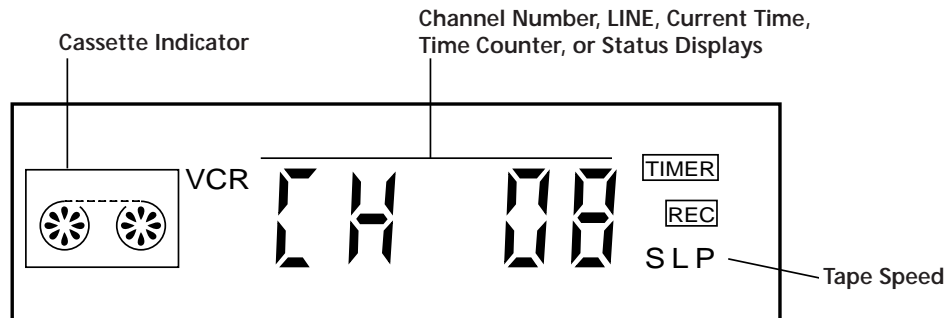

Cassette Indicator Shows when a cassette is inserted and displays direction tape is moving.

Time, Time Counter, Channel Number, Line Input Indicator (LINE), or Status Displays

Time or Time Counter Press INFO to switch between the current time and time counter.

Channel Number or Line Input Indicator The channel number appears when the VCR is tuned to a channel. The line indicator (LINE) appears when the line input is selected.

Status Indicators Show what the VCR is doing.

- EJECT Ejecting tape
- F-FWD Fast forward
- PLAY Playback
- REC Record
- REW Rewind
- SLOW Slow motion
- SEARCH + or - Forward or reverse search
- STILL Play pause and frame advance
- STOP VCR stopped
- X-REC Express recording

TIMER Indicator Lights when VCR is turned off and set for timer recording. Flashes when timer recording is set and there is no cassette in the VCR.

VCR Indicator (Applies only if the VCR Viewing Channel is 3 or 4). Press the TV•VCR button to turn on or off.

- VCR indicator on: Picture from VCR.
- VCR indicator off: Picture from TV channel.

APPENDIX A: REFERENCE

BACK PANEL

VCR

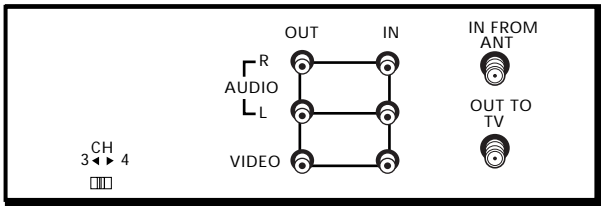

3CH4 Switch Selects the channel to which you will tune the TV to see the VCR picture if you connect the VCR using one of the basic hookups.

AUDIO (R and L) and VIDEO IN Jacks Receives signals from another component, like a VCR or camcorder, when it is connected to these jacks. Use INPUT on the remote to select LINE to record from these jacks.

AUDIO (R and L) and VIDEO OUT Jacks Sends signals from VCR to another component, like a TV or VCR, when it is connected to these jacks.

IN FROM ANT Jack Receives a signal from an antenna or cable system when attached.

OUT TO TV Jack Passes signal to TV using the cable supplied.

APPENDIX A: REFERENCE

TROUBLESHOOTING TIPS

No power

- Check to make sure it is plugged into an operating outlet.
- Check to make sure your connections are correct.

VCR does not respond to remote

- Press VCR to set remote to control the VCR.
- Check to make sure there are no objects between the VCR and remote.
- The batteries may need changing.
- Make sure the Remote VCR1/VCR2 setting is set to VCR1 so the remote that came packed with your VCR can operate it.
- Remove batteries and hold number button 1 for at least 60 seconds to drain the microprocessor inside the remote. Release number 1 and replace the batteries.
- Remove all batteries for approximately 12 hours. Then replace batteries.

Remote no longer controls an RCA, ProScan, or GE TV

- Press TV to set remote to control a compatible TV.
- Check to make sure the remote is programmed to control an RCA, ProScan, or GE TV.

Remote no longer controls a compatible TV

- Press TV to set remote to control the compatible TV.
- Check to make sure there are no objects between the component and remote.
- The batteries may need changing.
- Reprogram remote after batteries have been changed.
- Remove batteries and hold number button 1 for at least 60 seconds to drain the microprocessor inside the remote. Release number 1, replace the batteries, and (if necessary) reprogram the remote.
- Remove all batteries for approximately 12 hours. Then replace batteries and (if necessary) reprogram the remote.

Poor or no picture for normal TV viewing

- Check to make sure the VCR indicator is off.
- Check to make sure the TV is switched to an active channel.
- Check to make sure the antenna connections are secure and correct.

Snowy or no picture during playback

- Press TV•VCR to turn VCR indicator on.
- Check TV channel selected (3 or 4) to make sure it matches the channel selected with 3CH4 switch on back of VCR.
- Check to make sure the TV's fine tuning is correct for the channel you have selected.
- Check video cable connections between VCR and TV monitor.
- Check to make sure the TV monitor is set to video input.

APPENDIX A: REFERENCE

- Try another tape.
- Some snow/streaks are normal during search, stop action, frame advance, and slow-motion playback.

Streaks in picture during normal playback

- Press one of the TRACKING buttons to move streaks up or down for the best picture.
- Check to make sure the tape is of good quality and not worn out.

Will not record or play

- Check to make sure there is a tape in the VCR.
- Try ejecting and reinserting the cassette.
- Check to make sure the tape is not broken.
- Check to make sure the VCR is not in pause mode. Press PAUSE or PLAY to return to normal playback.

Will not record

- Check to make sure the safety tab is intact.
- Check to make sure the VCR is not in the line mode. Press INPUT.

VCR Plus+ or timer recording not made or wrong program recorded

- Check to make sure the correct VCR PlusCode is entered.
- Check to make sure the cable box was turned on when recording was to begin.
- Check to make sure the program was entered correctly (wrong channel or times).
- VCR cannot control cable box or satellite receiver. Check to make sure VCR was set up for cable box or DSS control or try repositioning the cable box.
- Power interruption. Reset the clock.
- Check to see if time and date are correct—including AM/PM.
- Check to make sure the program did not exceed the tape's length or the tape was not rewound beforehand.
- Check to make sure the VCR was turned off at the time recording was to start.
- Check to make sure there was a tape in the VCR and the cassette's safety tab was intact.
- VCR ejects cassette when the end of the tape is reached during a timer recording.
- Check to make sure VCR Plus+ channel setup was completed correctly.

Clock shows incorrect time or date

- Power interruption. Automatic clock set was not turned on or did not work properly. Check time zone and daylight-savings settings.
- Make sure VCR or cable box is tuned to channel carrying XDS information.
- Auto clock set is not supported by digital satellite receivers. Set the clock manually.

Time did not adjust for daylight-saving time

- Check to make sure daylight-saving feature is set correctly.

APPENDIX A: REFERENCE

VCR makes noise when stopped

- VCR is removing tape from heads. This is normal. The head cylinder inside the VCR will continue to rotate for a few minutes after you put the VCR in the stop mode.

Will not Auto Channel Search active channels correctly

- Check to make sure the antenna connections are secure and correct.
- Check to make sure the Signal Type: CABLE/ANTENNA feature is set correctly.
- If Detect Automatically was selected for the Signal Type in the Auto Channel Search menu, try using either CABLE TV or ANTENNA instead.

Tape plays back in slow motion

- Press PLAY to return to normal playback.

Cannot select channels over 69

- Cable channels over 69 can only be selected if Signal Type: CABLE/ANTENNA feature is set to CABLE.

Cassette with safety tab removed does not start to play automatically

- Check to make sure the Auto Play ON/OFF feature is set to ON.

No stereo sound during playback

- Check to make sure the Playback: HI-FI/LINEAR/MIX feature is set to HI-FI to hear stereo sound during playback.
- Must use the AUDIO/VIDEO jacks on the back of the VCR to hear stereo sound.

Stereo audio too noisy

- Stereo signal is weak. Set Reception: STEREO/MONO/SAP feature to MONO.
- Press one of the TRACKING up or down buttons to minimize the noise.

Cannot access MOVIE▶▶ADVANCE feature

- Cassette must have safety tab removed and be recorded in SP speed.
- Home Recording was selected as the Tape Type in the menu. Eject and reinsert the tape.

VCR forwards through commercials or momentarily displays a blue screen during playback.

- Commercial Advance Playback feature is set to AUTO. Set it to MANUAL.

COMMERCIAL▶▶ADVANCE feature does not mark commercials when:

- The Marking feature is set to OFF in the COMMERCIAL ADVANCE menu. Set it to ON.
- A recording is less than 15 minutes or the commercial is longer than one minute.
- A single isolated commercial can not be marked.
- Recording started in the middle of a commercial segment.
- A commercial group within the first or last two minutes of a recording.
- Accuracy and effectiveness can vary depending upon program content and the characteristics of the commercials.
- A commercial is between 30-and-45 seconds and 45-and-60 seconds.
- Effectiveness may vary when local television stations insert their own commercials.

APPENDIX A: REFERENCE

QUESTIONS AND ANSWERS ABOUT COMMERCIAL▶▶ADVANCE+

Will commercials be scanned through only on playback of recordings?

Yes. The VCR does not rewind and mark commercial segments until after recording is finished.

How fast does the COMMERCIAL▶▶ADVANCE VCR scan through the commercial breaks?

In SLP tape speed, a 3-minute commercial break is scanned through in approximately 8-12 seconds. In SP, it takes about 25-35 seconds.

Are commercials still recorded if I want to watch them?

Yes. The recorded program, including commercials, can be viewed by setting the Playback feature to MANUAL.

What if the VCR scans forward through part of my program?

Simply rewind the tape to just before the skipped segment, and press PLAY to view the program.

Once a recording has been marked, does COMMERCIAL▶▶ADVANCE work each time the tape is played?

Yes. If the Playback feature is set to AUTO, the marked commercials should be skipped each time the tape is played in a COMMERCIAL▶▶ADVANCE VCR.

After marking commercials, is the tape left at the beginning or end of the recording?

The tape is left at the end of the recording so it is in position to begin additional programmed recordings.

Does the marking process interfere with other programmed recordings?

No. If two or more recordings are programmed together without sufficient time to mark the first recording, marking will take place after all recordings have completed.

What happens if the marking process is interrupted?

Marking can be interrupted to allow use of the VCR. Marking will resume again when the VCR's power is turned off as long as the tape has not been ejected from the VCR.

Does COMMERCIAL▶▶ADVANCE work in all recording speeds?

Yes, COMMERCIAL▶▶ADVANCE works in SP and SLP.

Will COMMERCIAL▶▶ADVANCE marked recordings work in non-Commercial Advance VCRs?

A COMMERCIAL▶▶ADVANCE marked recording will play in a non-commercial advance VCR, but commercials will not automatically be skipped.

APPENDIX A: REFERENCE

SPECIFICATIONS

Format:	VHS
Record/Playback System:	Video: 4-head Audio: 2 Hi-Fi record/playback system
Video Signal System:	EIA standard: NTSC color
Antenna:	75-ohm external VHF/UHF combined antenna terminal
Tuner:	USA: 181 channels capability* (125 cable channels) Canada: 178 channels capability* (122 cable channels)
Type:	AutoProgramming frequency synthesis
Power Requirement:	120V AC, 60 Hz
Power Consumption:	18 watts
Dimensions:	3.7 inches high (92.5 mm) 15 inches wide (380 mm) 12.4 inches deep (313.5 mm)
Weight:	8.8 pounds (4.2 kg)
Storage Temperature Range:	- 22°F to +149°F (-30°C to +65°C)
Operating Temperature Range:	+41°F to +104°F (+5°C to +40°C)

*Check your cable company's compatibility requirements.

CLEANING THE VCR

Use a soft cloth or dusting attachment of your vacuum cleaner to dust your VCR. Remove dust from the ventilation holes on the top, back, sides, and bottom of the cabinet.

Plastic surfaces are easily scratched and can be marred by alcohol and various solvents. Avoid excessive use of oil-based furniture polishes since the materials used in the cabinet will accumulate more dust. We recommend using a nonabrasive, antistatic cleaner and polisher.

Specifications are subject to change.

APPENDIX A: REFERENCE

LIMITED WARRANTY

What your warranty covers:

- Any defect in material or workmanship.

For how long after your purchase:

- Ninety days for labor charges.
- One year for parts.

The warranty period for rental units begins with the first rental or 45 days from date of shipment to the rental firm, whichever comes first.

What we will do:

- Pay any Authorized RCA VCR Servicenter the labor charges to repair your VCR.
- Pay any Authorized RCA VCR Servicenter for the new or, at our option, refurbished replacement parts required to repair your VCR.

How you get service:

- Take your VCR to any Authorized RCA VCR Servicenter. To identify your nearest Authorized RCA VCR Servicenter, ask your dealer, look in the Yellow Pages, or call 1-800-336-1900.
- Show the service technician your evidence of purchase date.
- Pick up your VCR when repairs are completed.

What your warranty does not cover:

- Customer instruction. (Your Owner's Manual clearly describes how to install, adjust, and operate your VCR. Any additional information should be obtained from your Dealer.)
- Installation and related adjustments.
- Signal reception problems not caused by your VCR.
- Damage from misuse or neglect.
- Cleaning of video/audio heads.
- Remote control batteries.
- A VCR that has been modified or incorporated into other products or is used for institutional or other commercial purposes.
- A VCR purchased or serviced outside the USA.
- Acts of God, such as but not limited to lightning damage.

Product Registration:

- Please complete and mail the Product Registration Card packed with your VCR. It will make it easier to contact you should it ever be necessary. The return of the card is not required for warranty coverage.

How state law relates to this warranty:

- This warranty gives you specific legal rights, and you also may have other rights that vary from state to state.

If you purchased your VCR outside the United States:

- This warranty does not apply. Contact your dealer for warranty information.

INDEX

3CH4 switch 52, 55, 60

A

Accessing menus 5
Add or remove channels 11
ADD/REMOVE CHANNELS screen 11
Audio
 playback type 48
 selecting 48
Audio features, set up 47
AUDIO menu 47
Audio only
 playing back 33
 recording 33
Audio/Video jacks 33
Audio/video jacks 33, 51, 53, 54, 56, 60
Auto channel search 10
AUTO CHANNEL SEARCH menu 10
Auto Clock 12
Auto clock set 12
Auto play feature 18, 24
Auto TV/VCR feature 18, 51, 52, 53, 54, 55, 56
Automatic rewind 24
Automatic tracking 24

B

Back panel 60
Basic recording 25
Basics, learn the 21
Batteries, installing in the remote 4
Broadcast stereo TV recording 32

C

Cable box setup 8
CABLE BOX SETUP menu 9
Cables
 positioning 49
 types of 50
Cassette indicator 59
CHAN buttons 22, 36
CHANNEL buttons 58
Channel number display 59
Channel, viewing 5
Channels, add or remove 11
Channels list, VCR 10
CHANNELS menu 9, 10, 11, 15, 30
Choosing a VCR connection 51

Cleaning the VCR 65
CLEAR button 22, 31, 32, 45, 46
Clearing programs 32
COMMERCIAL▶▶ADVANCE 38
 display 40
 marking 39
 marking an unmarked tape 40, 41
 marking feature 39
 menu 39, 40
 playback 37, 40
 questions and answers 64
Connections 49
 choosing 51
 TV with audio/video jacks 53
 TV with audio/video jacks and cable box to unscram
 54
 TV with audio/video jacks and satellite receiver 56
 TV with RF jack and satellite receiver 55
 TV with RF jack only 52
 two VCRs 34
 using audio/video cables 51
Contents 1
Controls
 back panel 60
 front panel 58
Copying and editing tapes 34

D

Date and time setting 12
Daylight Saving Time 13
Displays
 on-screen 46, 59

E

EJECT button 25, 58
Eject, tape 25
Express recording 28

F

F.ADV button 22, 23, 44
First setup 3
First things first 3
FORWARD button 22, 24, 43, 44, 45, 46
Frame advance 44
Front panel controls 58
Front panel display feature 19
FWD button 34, 43, 44, 45, 46, 58

INDEX

G

GO BACK button 22, 23, 42
Go-to search feature 45
GO-TO SEARCH menu 45

I

IN FROM ANT jack 18, 51, 52, 55, 60
Index search feature 44
INDEX SEARCH menu 44
INFO button 22, 23, 46, 59
INPUT button 22, 29, 33, 58

J

Jacks, types of 50

L

Language feature 8
LANGUAGE menu 8
Limited warranty 66
LINE indicator 33, 55, 59

M

Marking an unmarked tape 40
MENU button
 6, 8, 9, 10, 11, 12, 13, 14, 15, 17, 22, 29, 30, 31, 32, 33, 41, 47
Menus, accessing 5
MOVIE▶▶ADVANCE 41, 42
MUTE button 23

N

Number buttons 23, 24

O

OFF button 22, 23, 24, 36
On-screen displays 46
OUT TO TV jack 18, 51, 52, 55, 60
Overheating 49

P

PAUSE button 23, 24, 25, 34, 44, 58
Picture search options 43

PLAY button

 23, 24, 34, 43, 44, 46, 52, 53, 54, 55, 56, 58

Playing a tape 24

POWER button 58

Power surges 49

PREFERENCES menu 6, 17, 18, 39

Problem solving 61

PROGRAMS OVERLAP message 29, 31

R

Reception: STEREO/MONO/SAP 33

Reception: STEREO/MONO/SAP feature 48

RECORD button 23, 25, 28, 33, 34, 58

Recording

 audio only 33

 basic 25

 broadcast stereo TV 32

 copying and editing tapes 34

 express 28

 features 28

 SAP 32

 speeds 25

 timer 29

 VCR plus+ 30

Remote

 buttons 22

 component buttons 22

 installing batteries 4

 TV function buttons 23

 VCR function buttons 22–24

Remote VCR1/VCR2 option 17

Remove or add channels 11

REV button 34, 43, 44, 45, 58

REVERSE button 23, 24, 43, 44, 45

Review programs screen 32

Reviewing programs 32

Rewind, automatic 24

S

Safety tab 25

SAP, recording 32

Search

 forward 43

 frame advance 44

 go-to 45

 index 44

 MOVIE▶▶ADVANCE 41

 reverse 43

 slow motion 44

INDEX

SEARCH button 23, 40, 41, 44, 45
Sensor, remote 58
SET DAYLIGHT SAVINGS screen 13
Set time and date manually 14
SET TIME AND DATE menu 14
SET TIME ZONE screen 13
Set up
 audio features 47
 cable box 8
 first 3
 language 8
 using the menus 8
Signal type
 changing 11
 selecting 11
Slow motion playback 44
Solving problems 61
Specifications 65
Speed
 LP 25
 SLP 25
 SP 25
SPEED button 23, 25, 28, 31, 33
Speeds, recording 25
Status indicators
 EJECT 59
 F-FWD 59
 PLAY 59
 REC 59
 REW 59
 SEARCH + and - 59
 STILL 59
 STOP 59
 X-REC 59
STEREO indicator 48
STOP button 23, 24, 25, 28, 32, 33, 34, 45, 46, 58
Stopping a timer recording 32

T

Tab, safety 25
Table of contents 1
Tape eject 25
Tape playback 48
Tape playback: HIFI, LINEAR and MIX 48
Tape, playing a 24
Tape speeds 25
Time and date setting 12
Time counter 45
Time counter display 59
Time display 59

TIME menu 12, 13, 14
Time setting
 set daylight saving 13
 set time zone 13
TIMER indicator 29, 31, 59
Timer recording 29
Timer recording, stopping 32
TIMER RECORDINGS menu 29, 32
Tips, troubleshooting 61
TRACKING button 24
TRACKING buttons 23, 44, 46, 58
Tracking feature 46
Troubleshooting tips 61
TV button 22, 36
TV codes 36
TV•VCR button 18, 23, 33, 51, 52, 53, 55, 56, 58

V

VCR button 18, 22
VCR channels list 10
VCR, cleaning 65
VCR indicator 33, 59
VCR MAIN MENU
 6, 8, 9, 10, 11, 13, 14, 15, 17, 22, 29, 30, 32, 38, 47
VCR Plus+
 channel list 30
 channel list menu 15, 30
 menu 30
 PlusCode number 31
 setting up channels 15
 using 30
 worksheet for channels 16
Viewing channel 5
VOL buttons 24

W

Warranty, limited 66

If your VCR needs service, please contact your dealer or the nearest Servicenter from the yellow pages. Please do not send any products to the Indianapolis address listed in this manual or on the carton. This will only add delays in service for your product.

 **THOMSON CONSUMER ELECTRONICS**

10330 North Meridian Street
Indianapolis, IN 46290

©1997 Thomson Consumer Electronics, Inc.

Trademark(s)® Registered

Marca(s) Registrada(s)

Printed in Indonesia

TOCOM 15244100